

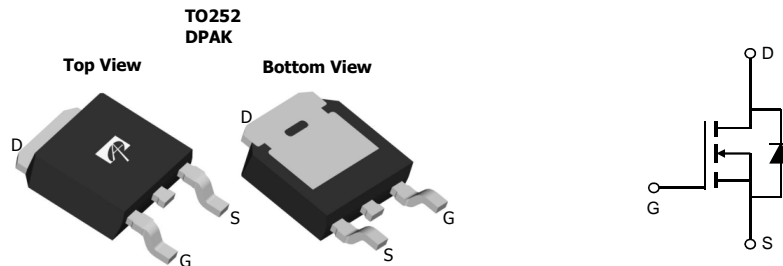
### General Description

The AOD2916 uses trench MOSFET technology that is uniquely optimized to provide the most efficient high frequency switching performance. Both conduction and switching power losses are minimized due to an extremely low combination of  $R_{DS(ON)}$ ,  $C_{iss}$  and  $C_{oss}$ . This device is ideal for boost converters and synchronous rectifiers for consumer, telecom, industrial power supplies and LED backlighting.

### Product Summary

|                                  |                  |
|----------------------------------|------------------|
| $V_{DS}$                         | 100V             |
| $I_D$ (at $V_{GS}=10V$ )         | 25A              |
| $R_{DS(ON)}$ (at $V_{GS}=10V$ )  | < 34m $\Omega$   |
| $R_{DS(ON)}$ (at $V_{GS}=4.5V$ ) | < 43.5m $\Omega$ |

100% UIS Tested  
 100%  $R_g$  Tested



### Absolute Maximum Ratings $T_A=25^\circ\text{C}$ unless otherwise noted

| Parameter                                      | Symbol         | Maximum                 | Units            |
|--|----------------|-------------------------|------------------|
| Drain-Source Voltage                           | $V_{DS}$       | 100                     | V                |
| Gate-Source Voltage                            | $V_{GS}$       | $\pm 20$                | V                |
| Continuous Drain Current                       | $I_D$          | $T_C=25^\circ\text{C}$  | 25               |
|  |                | $T_C=100^\circ\text{C}$ | 18               |
| Pulsed Drain Current <sup>C</sup>              | $I_{DM}$       | 50                      | A                |
| Continuous Drain Current                       | $I_{DSM}$      | $T_A=25^\circ\text{C}$  | 5.5              |
|  |                | $T_A=70^\circ\text{C}$  | 4.5              |
| Avalanche Current <sup>C</sup>                 | $I_{AS}$       | 8                       | A                |
| Avalanche energy $L=0.1\text{mH}$ <sup>C</sup> | $E_{AS}$       | 3                       | mJ               |
| Power Dissipation <sup>B</sup>                 | $P_D$          | $T_C=25^\circ\text{C}$  | 50               |
|  |                | $T_C=100^\circ\text{C}$ | 25               |
| Power Dissipation <sup>A</sup>                 | $P_{DSM}$      | $T_A=25^\circ\text{C}$  | 2.5              |
|  |                | $T_A=70^\circ\text{C}$  | 1.6              |
| Junction and Storage Temperature Range         | $T_J, T_{STG}$ | -55 to 175              | $^\circ\text{C}$ |

### Thermal Characteristics

| Parameter                                  | Symbol          | Typ | Max | Units                     |
|--|-----------------|-----|-----|---------------------------|
| Maximum Junction-to-Ambient <sup>A</sup>   | $R_{\theta JA}$ | 15  | 20  | $^\circ\text{C}/\text{W}$ |
| Maximum Junction-to-Ambient <sup>A D</sup> |                 | 41  | 50  | $^\circ\text{C}/\text{W}$ |
| Maximum Junction-to-Case                   | $R_{\theta JC}$ | 2.5 | 3   | $^\circ\text{C}/\text{W}$ |

**Electrical Characteristics (T<sub>J</sub>=25°C unless otherwise noted)**

| Symbol                      | Parameter                             | Conditions  | Min | Typ      | Max      | Units |
|-----------------------------|---------------------------------------|---|-----|----------|----------|-------|
| <b>STATIC PARAMETERS</b>    |                                       |   |     |          |          |       |
| BV <sub>DSS</sub>           | Drain-Source Breakdown Voltage        | I <sub>D</sub> =250μA, V <sub>GS</sub> =0V  | 100 |          |          | V     |
| I <sub>DSS</sub>            | Zero Gate Voltage Drain Current       | V <sub>DS</sub> =100V, V <sub>GS</sub> =0V<br>T <sub>J</sub> =55°C                      |     |          | 1<br>5   | μA    |
| I <sub>GSS</sub>            | Gate-Body leakage current             | V <sub>DS</sub> =0V, V <sub>GS</sub> =±20V  |     |          | ±100     | nA    |
| V <sub>GS(th)</sub>         | Gate Threshold Voltage                | V <sub>DS</sub> =V <sub>GS</sub> , I <sub>D</sub> =250μA                                | 1.6 | 2.15     | 2.7      | V     |
| I <sub>D(ON)</sub>          | On state drain current                | V <sub>GS</sub> =10V, V <sub>DS</sub> =5V   | 50  |          |          | A     |
| R <sub>DS(ON)</sub>         | Static Drain-Source On-Resistance     | V <sub>GS</sub> =10V, I <sub>D</sub> =10A<br>T <sub>J</sub> =125°C                      |     | 28<br>51 | 34<br>62 | mΩ    |
|                             |                                       | V <sub>GS</sub> =4.5V, I <sub>D</sub> =3A   |     | 35       | 43.5     |       |
| g <sub>FS</sub>             | Forward Transconductance              | V <sub>DS</sub> =5V, I <sub>D</sub> =10A  |     | 28       |          | S     |
| V <sub>SD</sub>             | Diode Forward Voltage                 | I <sub>S</sub> =1A, V <sub>GS</sub> =0V   |     | 0.75     | 1        | V     |
| I <sub>S</sub>              | Maximum Body-Diode Continuous Current |   |     |          | 26       | A     |
| <b>DYNAMIC PARAMETERS</b>   |                                       |   |     |          |          |       |
| C <sub>iss</sub>            | Input Capacitance                     | V <sub>GS</sub> =0V, V <sub>DS</sub> =50V, f=1MHz                                       |     | 870      |          | pF    |
| C <sub>oss</sub>            | Output Capacitance                    |   |     | 68       |          | pF    |
| C <sub>riss</sub>           | Reverse Transfer Capacitance          |   |     | 3.5      |          | pF    |
| R <sub>g</sub>              | Gate resistance                       | V <sub>GS</sub> =0V, V <sub>DS</sub> =0V, f=1MHz  |     | 7        |          | Ω     |
| <b>SWITCHING PARAMETERS</b> |                                       |   |     |          |          |       |
| Q <sub>g(10V)</sub>         | Total Gate Charge                     | V <sub>GS</sub> =10V, V <sub>DS</sub> =50V, I <sub>D</sub> =10A                         |     | 12.5     | 20       | nC    |
| Q <sub>g(4.5V)</sub>        | Total Gate Charge                     |   |     | 5.5      | 10       | nC    |
| Q <sub>gs</sub>             | Gate Source Charge                    |   |     | 2.5      |          | nC    |
| Q <sub>gd</sub>             | Gate Drain Charge                     |   |     | 2        |          | nC    |
| t <sub>D(on)</sub>          | Turn-On DelayTime                     | V <sub>GS</sub> =10V, V <sub>DS</sub> =50V, R <sub>L</sub> =5Ω,<br>R <sub>GEN</sub> =3Ω |     | 7.5      |          | ns    |
| t <sub>r</sub>              | Turn-On Rise Time                     |   |     | 3.5      |          | ns    |
| t <sub>D(off)</sub>         | Turn-Off DelayTime                    |   |     | 23       |          | ns    |
| t <sub>f</sub>              | Turn-Off Fall Time                    |   |     | 5.5      |          | ns    |
| t <sub>rr</sub>             | Body Diode Reverse Recovery Time      | I <sub>F</sub> =10A, dI/dt=500A/μs  |     | 20       |          | ns    |
| Q <sub>rr</sub>             | Body Diode Reverse Recovery Charge    | I <sub>F</sub> =10A, dI/dt=500A/μs  |     | 88       |          | nC    |

A. The value of R<sub>θJA</sub> is measured with the device mounted on 1in<sup>2</sup> FR-4 board with 2oz. Copper, in a still air environment with T<sub>A</sub>=25° C. The Power dissipation P<sub>DSM</sub> is based on R<sub>θJA</sub> and the maximum allowed junction temperature of 150° C. The value in any given application depends on the user's specific board design, and the maximum temperature of 175° C may be used if the PCB allows it.

B. The power dissipation P<sub>D</sub> is based on T<sub>J(MAX)</sub>=175° C, using junction-to-case thermal resistance, and is more useful in setting the upper dissipation limit for cases where additional heatsinking is used.

C. Repetitive rating, pulse width limited by junction temperature T<sub>J(MAX)</sub>=175° C. Ratings are based on low frequency and duty cycles to keep initial T<sub>J</sub>=25° C.

D. The R<sub>θJA</sub> is the sum of the thermal impedance from junction to case R<sub>θJC</sub> and case to ambient.

E. The static characteristics in Figures 1 to 6 are obtained using <300μs pulses, duty cycle 0.5% max.

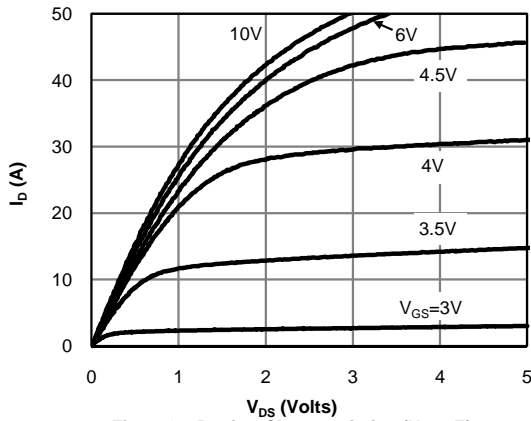
F. These curves are based on the junction-to-case thermal impedance which is measured with the device mounted to a large heatsink, assuming a maximum junction temperature of T<sub>J(MAX)</sub>=175° C. The SOA curve provides a single pulse rating.

G. The maximum current rating is package limited.

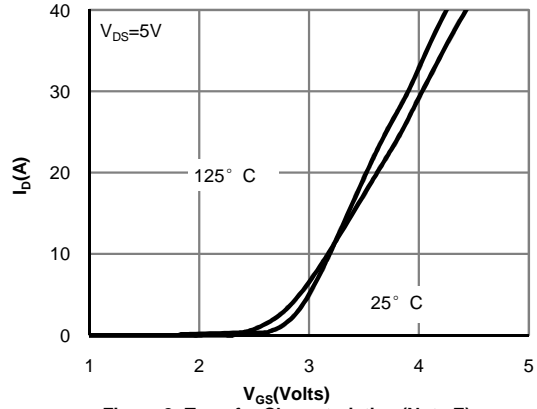
H. These tests are performed with the device mounted on 1 in<sup>2</sup> FR-4 board with 2oz. Copper, in a still air environment with T<sub>A</sub>=25° C.

THIS PRODUCT HAS BEEN DESIGNED AND QUALIFIED FOR THE CONSUMER MARKET. APPLICATIONS OR USES AS CRITICAL COMPONENTS IN LIFE SUPPORT DEVICES OR SYSTEMS ARE NOT AUTHORIZED. AOS DOES NOT ASSUME ANY LIABILITY ARISING OUT OF SUCH APPLICATIONS OR USES OF ITS PRODUCTS. AOS RESERVES THE RIGHT TO IMPROVE PRODUCT DESIGN, FUNCTIONS AND RELIABILITY WITHOUT NOTICE.

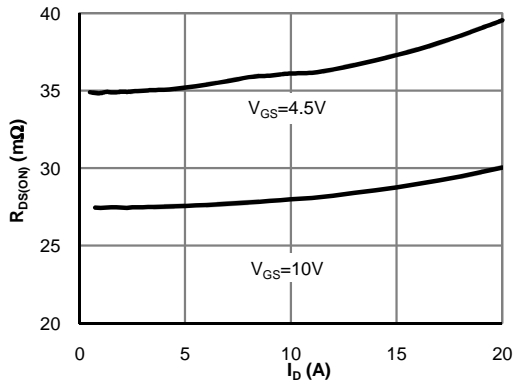
**TYPICAL ELECTRICAL AND THERMAL CHARACTERISTICS**



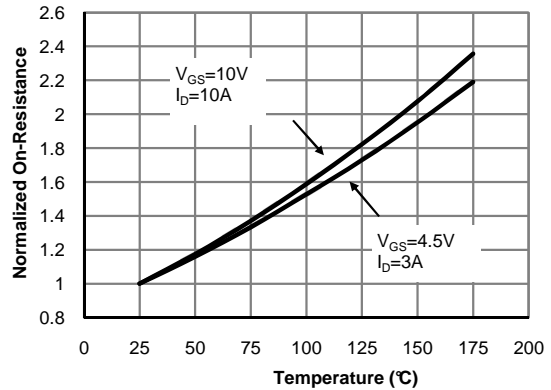
**Figure 1: On-Region Characteristics (Note E)**



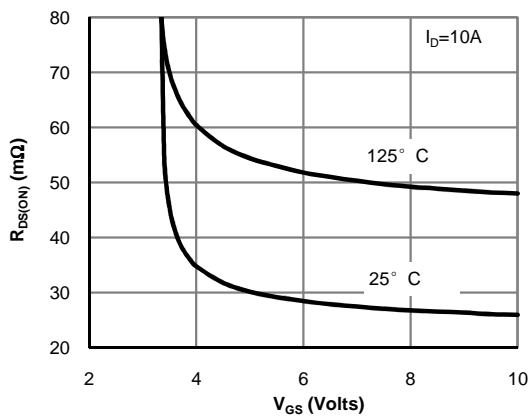
**Figure 2: Transfer Characteristics (Note E)**



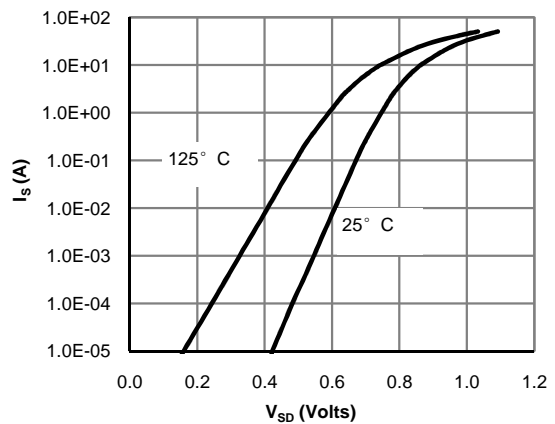
**Figure 3: On-Resistance vs. Drain Current and Gate Voltage (Note E)**



**Figure 4: On-Resistance vs. Junction Temperature (Note E)**

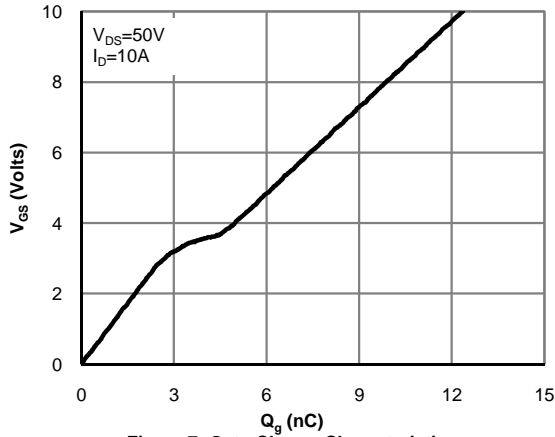


**Figure 5: On-Resistance vs. Gate-Source Voltage (Note E)**

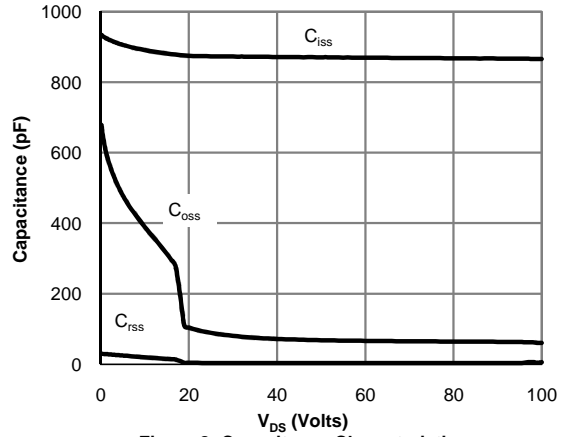


**Figure 6: Body-Diode Characteristics (Note E)**

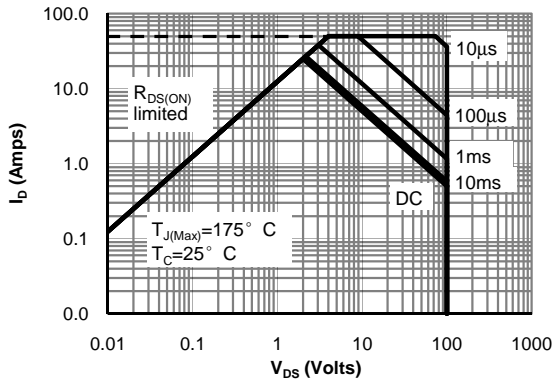
**TYPICAL ELECTRICAL AND THERMAL CHARACTERISTICS**



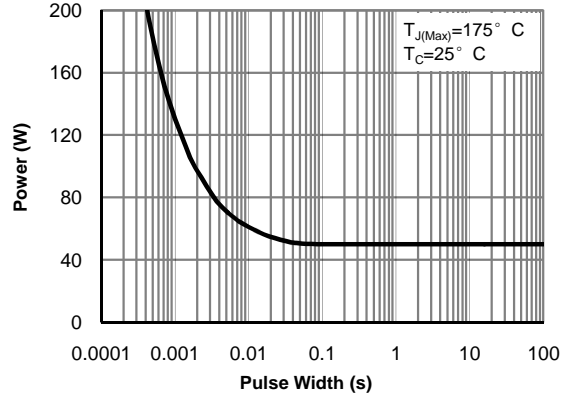
**Figure 7: Gate-Charge Characteristics**



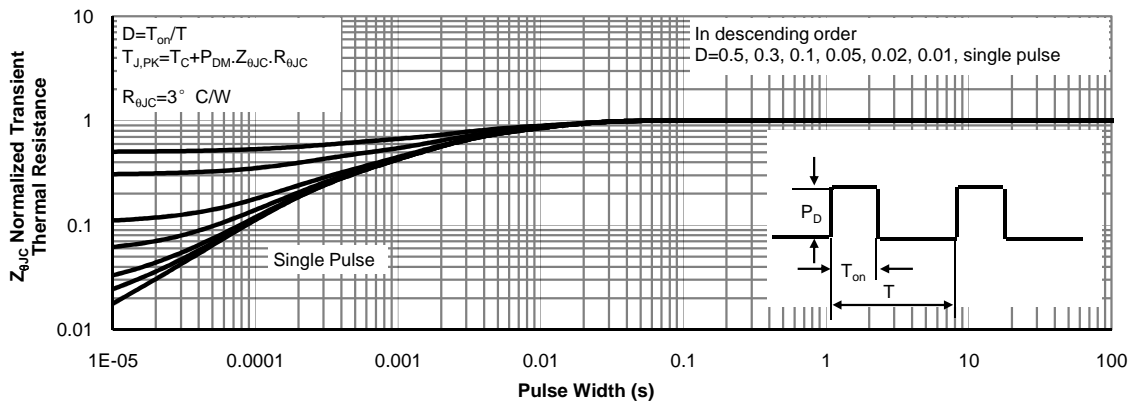
**Figure 8: Capacitance Characteristics**



**Figure 9: Maximum Forward Biased Safe Operating Area (Note F)**



**Figure 10: Single Pulse Power Rating Junction-to-Case (Note F)**



**Figure 11: Normalized Maximum Transient Thermal Impedance (Note F)**

**TYPICAL ELECTRICAL AND THERMAL CHARACTERISTICS**

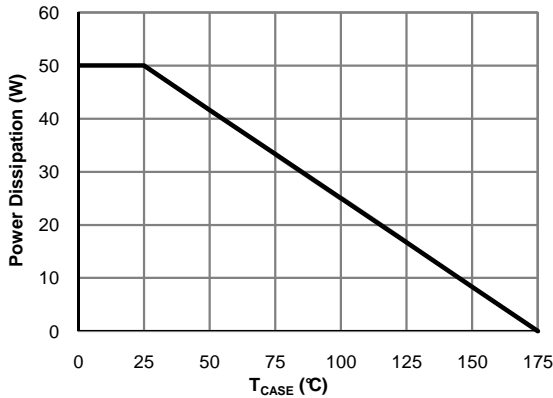


Figure 12: Power De-rating (Note F)

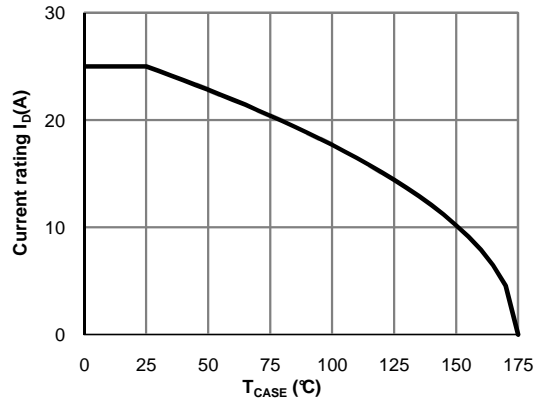


Figure 13: Current De-rating (Note F)

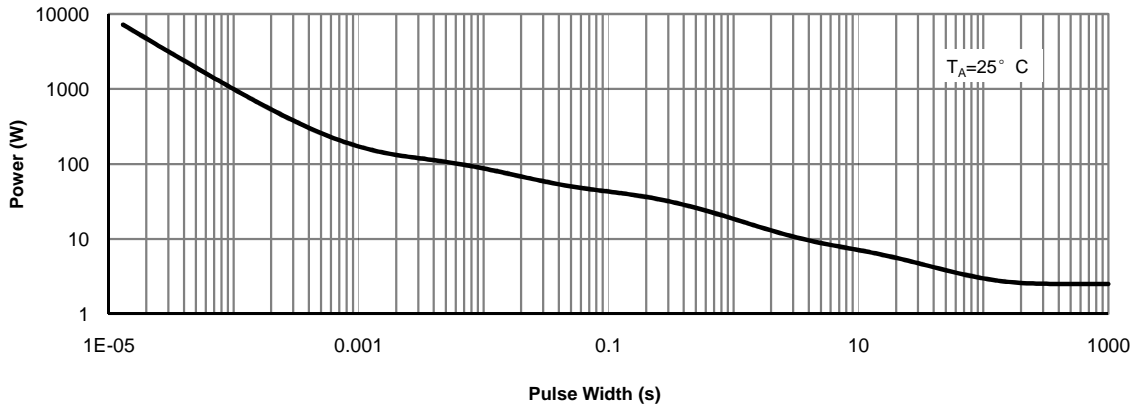


Figure 14: Single Pulse Power Rating Junction-to-Ambient (Note H)

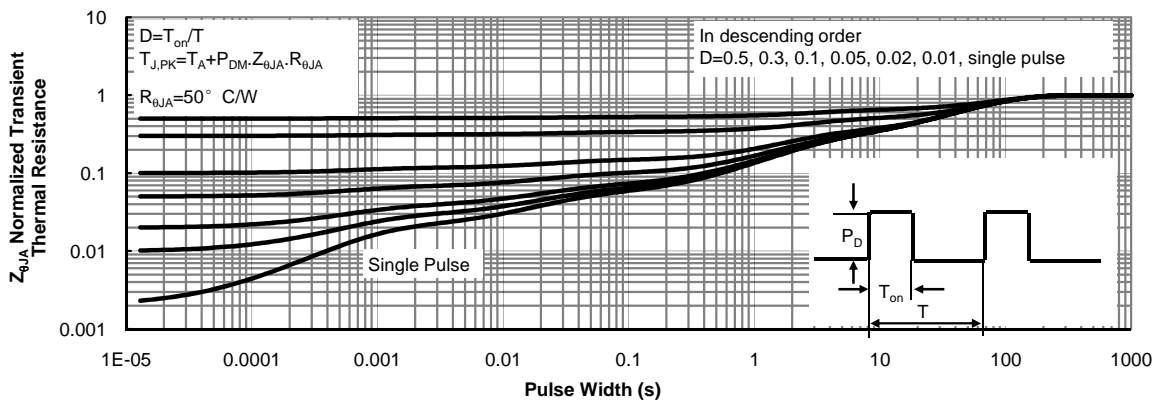
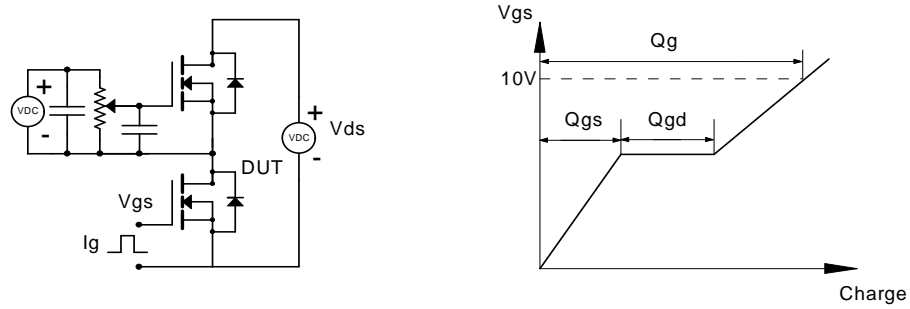
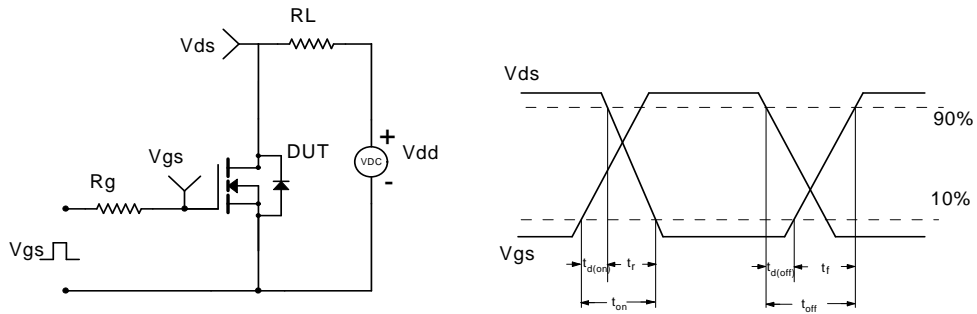


Figure 15: Normalized Maximum Transient Thermal Impedance (Note H)

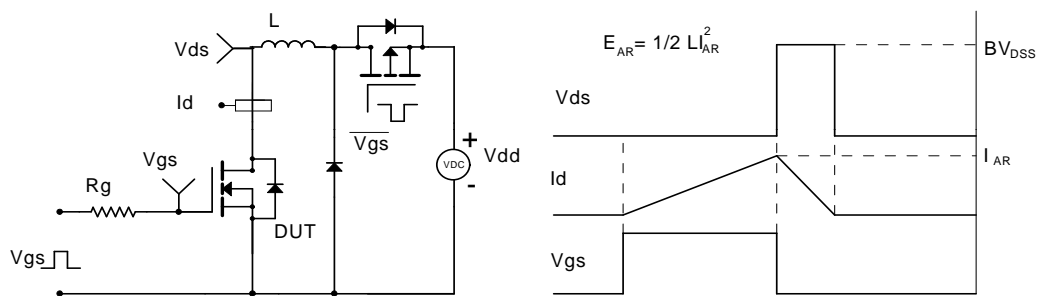
**Gate Charge Test Circuit & Waveform**



**Resistive Switching Test Circuit & Waveforms**



**Unclamped Inductive Switching (UIS) Test Circuit & Waveforms**



**Diode Recovery Test Circuit & Waveforms**

