



General Description

- Trench Power AlphaMOS-II technology
- Low $R_{DS(ON)}$
- Low C_{iss} and C_{rss}
- High Current Capability

Applications

- General Lighting for LED and CCFL
- AC/DC Power supplies for Industrial, Consumer, and Telecom

Product Summary

$V_{DS} @ T_{j,max}$	700V
I_{DM}	44A
$R_{DS(ON),max}$	< 0.42 Ω
$Q_{g,typ}$	31nC
$E_{oss} @ 400V$	5.4 μ J

100% UIS Tested
100% R_g Tested

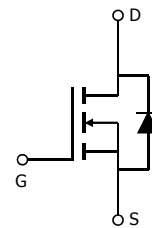
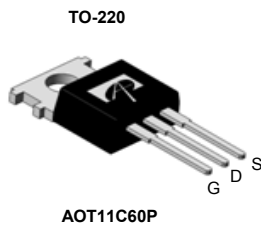

Orderable Part Number	Package Type	Form	Minimum Order Quantity
AOT11C60PL	TO-220 Green	Tube	1000

Absolute Maximum Ratings $T_A=25^\circ\text{C}$ unless otherwise noted

Parameter	Symbol	Maximum	Units
Drain-Source Voltage	V_{DS}	600	V
Gate-Source Voltage	V_{GS}	± 30	V
Continuous Drain Current	I_D	$T_C=25^\circ\text{C}$	11
		$T_C=100^\circ\text{C}$	9
Pulsed Drain Current ^C	I_{DM}	44	A
Avalanche Current ^C L=1mH	I_{AR}	11	A
Repetitive avalanche energy ^C	E_{AR}	60	mJ
Single pulsed avalanche energy ^G	E_{AS}	940	mJ
MOSFET dv/dt ruggedness	dv/dt	100	V/ns
Peak diode recovery dv/dt		20	
Power Dissipation ^B	P_D	$T_C=25^\circ\text{C}$	298
		Derate above 25 $^\circ\text{C}$	2.4
Junction and Storage Temperature Range	T_J, T_{STG}	-55 to 150	$^\circ\text{C}$
Maximum lead temperature for soldering purpose, 1/8" from case for 5 seconds	T_L	300	$^\circ\text{C}$

Thermal Characteristics

Parameter	Symbol	Maximum	Units
Maximum Junction-to-Ambient ^{A,D}	$R_{\theta JA}$	65	$^\circ\text{C}/\text{W}$
Maximum Case-to-sink ^A	$R_{\theta CS}$	0.5	$^\circ\text{C}/\text{W}$
Maximum Junction-to-Case	$R_{\theta JC}$	0.35	$^\circ\text{C}/\text{W}$

Electrical Characteristics (T_J=25°C unless otherwise noted)

Symbol	Parameter	Conditions	Min	Typ	Max	Units	
STATIC PARAMETERS							
BV _{DSS}	Drain-Source Breakdown Voltage	I _D =250μA, V _{GS} =0V, T _J =25°C	600			V	
		I _D =250μA, V _{GS} =0V, T _J =150°C		700			
BV _{DSS} /ΔT _J	Breakdown Voltage Temperature Coefficient	I _D =250μA, V _{GS} =0V		0.54		V/°C	
I _{DSS}	Zero Gate Voltage Drain Current	V _{DS} =600V, V _{GS} =0V			1	μA	
		V _{DS} =480V, T _J =125°C			10		
I _{GSS}	Gate-Body leakage current	V _{DS} =0V, V _{GS} =±30V			±100	nA	
V _{GS(th)}	Gate Threshold Voltage	V _{DS} =5V, I _D =250μA	3	4	5	V	
R _{DS(ON)}	Static Drain-Source On-Resistance	V _{GS} =10V, I _D =5.5A		0.36	0.42	Ω	
g _{FS}	Forward Transconductance	V _{DS} =40V, I _D =5.5A		11		S	
V _{SD}	Diode Forward Voltage	I _S =1A, V _{GS} =0V		0.72	1	V	
I _S	Maximum Body-Diode Continuous Current				11	A	
I _{SM}	Maximum Body-Diode Pulsed Current ^C				44	A	
DYNAMIC PARAMETERS							
C _{iss}	Input Capacitance	V _{GS} =0V, V _{DS} =100V, f=1MHz		2333		pF	
C _{oss}	Output Capacitance				91		pF
C _{o(er)}	Effective output capacitance, energy related ^H	V _{GS} =0V, V _{DS} =0 to 480V, f=1MHz		63		pF	
C _{o(tr)}	Effective output capacitance, time related ^I				117		pF
C _{rss}	Reverse Transfer Capacitance	V _{GS} =0V, V _{DS} =100V, f=1MHz		2.4		pF	
R _g	Gate resistance	f=1MHz		2.9		Ω	
SWITCHING PARAMETERS							
Q _g	Total Gate Charge	V _{GS} =10V, V _{DS} =480V, I _D =11A		31	50	nC	
Q _{gs}	Gate Source Charge			12			nC
Q _{gd}	Gate Drain Charge			4.3			nC
t _{D(on)}	Turn-On DelayTime	V _{GS} =10V, V _{DS} =300V, I _D =11A, R _G =25Ω		55		ns	
t _r	Turn-On Rise Time			41		ns	
t _{D(off)}	Turn-Off DelayTime			83		ns	
t _f	Turn-Off Fall Time			26		ns	
t _{rr}	Body Diode Reverse Recovery Time	I _F =11A, dI/dt=100A/μs, V _{DS} =100V		470		ns	
Q _{rr}	Body Diode Reverse Recovery Charge	I _F =11A, dI/dt=100A/μs, V _{DS} =100V		6.8		μC	

A. The value of R_{θJA} is measured with the device in a still air environment with T_A=25° C.

B. The power dissipation P_D is based on T_{J(MAX)}=150° C, using junction-to-case thermal resistance, and is more useful in setting the upper dissipation limit for cases where additional heatsinking is used.

C. Repetitive rating, pulse width limited by junction temperature T_{J(MAX)}=150° C, Ratings are based on low frequency and duty cycles to keep initial T_J=25° C.

D. The R_{θJA} is the sum of the thermal impedance from junction to case R_{θJC}, and case to ambient.

E. The static characteristics in Figures 1 to 6 are obtained using <300μs pulses, duty cycle 0.5% max.

F. These curves are based on the junction-to-case thermal impedance which is measured with the device mounted to a large heatsink, assuming a maximum junction temperature of T_{J(MAX)}=150° C. The SOA curve provides a single pulse rating.

G. L=60mH, I_{AS}=5.6A, V_{DD}=150V, R_G=25Ω, Starting T_J=25° C.

H. C_{o(er)} is a fixed capacitance that gives the same stored energy as C_{oss} while V_{DS} is rising from 0 to 80% V_{(BR)DSS}.

I. C_{o(tr)} is a fixed capacitance that gives the same charging time as C_{oss} while V_{DS} is rising from 0 to 80% V_{(BR)DSS}.

THIS PRODUCT HAS BEEN DESIGNED AND QUALIFIED FOR THE CONSUMER MARKET. APPLICATIONS OR USES AS CRITICAL COMPONENTS IN LIFE SUPPORT DEVICES OR SYSTEMS ARE NOT AUTHORIZED. AOS DOES NOT ASSUME ANY LIABILITY ARISING OUT OF SUCH APPLICATIONS OR USES OF ITS PRODUCTS. AOS RESERVES THE RIGHT TO IMPROVE PRODUCT DESIGN, FUNCTIONS AND RELIABILITY WITHOUT NOTICE.

TYPICAL ELECTRICAL AND THERMAL CHARACTERISTICS

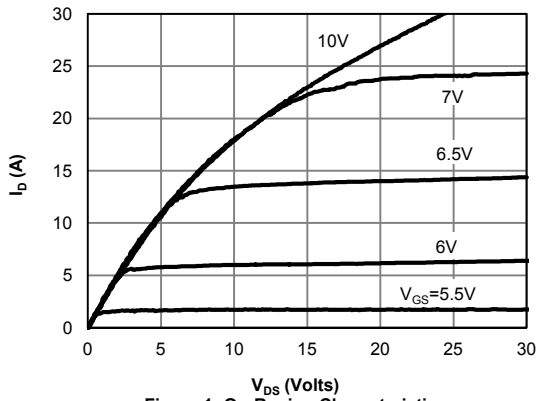

Figure 1: On-Region Characteristics

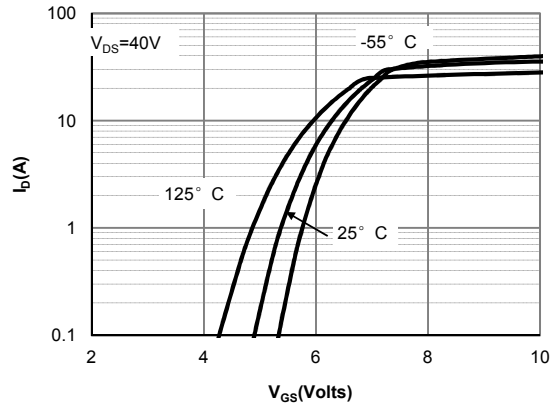

Figure 2: Transfer Characteristics

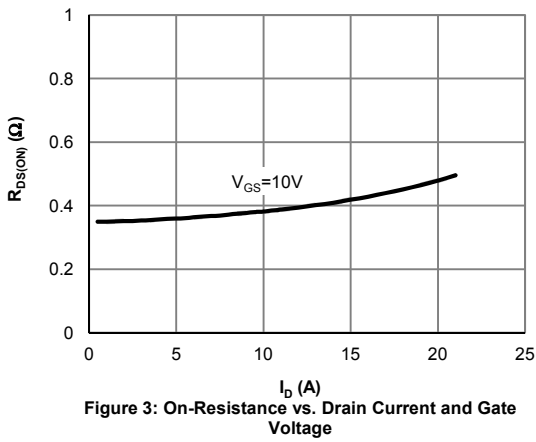

Figure 3: On-Resistance vs. Drain Current and Gate Voltage

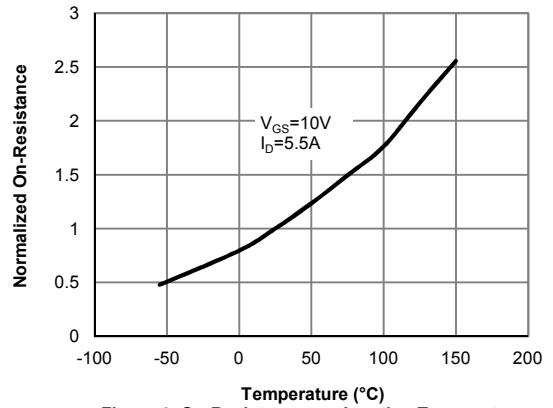

Figure 4: On-Resistance vs. Junction Temperature

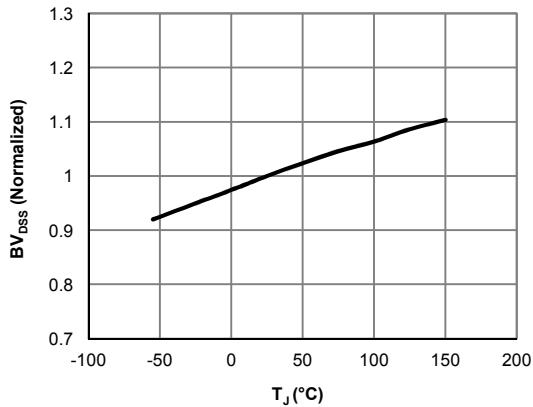

Figure 5: Break Down vs. Junction Temperature

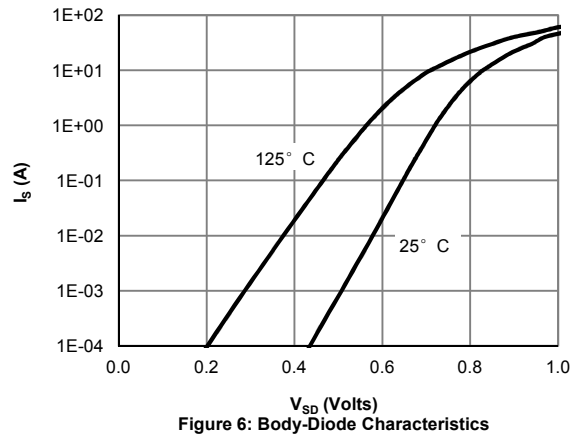

Figure 6: Body-Diode Characteristics

TYPICAL ELECTRICAL AND THERMAL CHARACTERISTICS

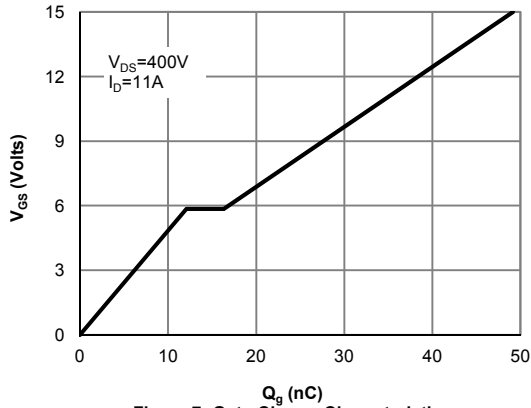

Figure 7: Gate-Charge Characteristics

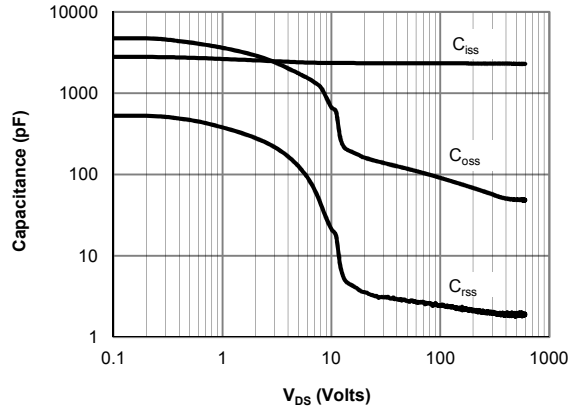

Figure 8: Capacitance Characteristics

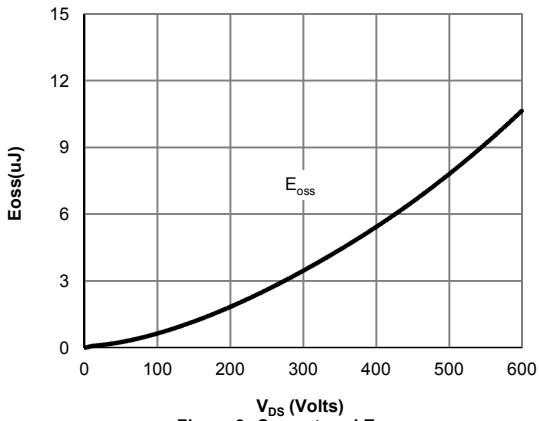

Figure 9: Coss stored Energy

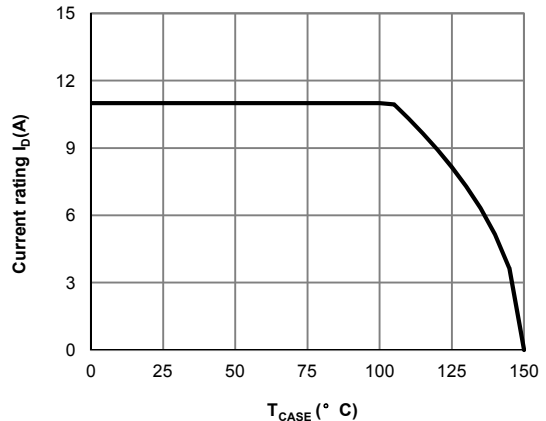

Figure 10: Current De-rating (Note F)

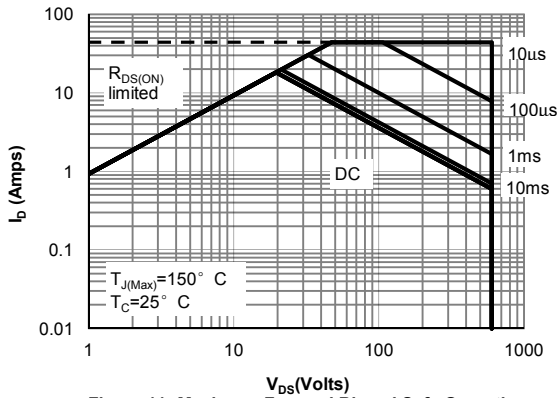

Figure 11: Maximum Forward Biased Safe Operating Area for TO-220 Green (Note F)

TYPICAL ELECTRICAL AND THERMAL CHARACTERISTICS

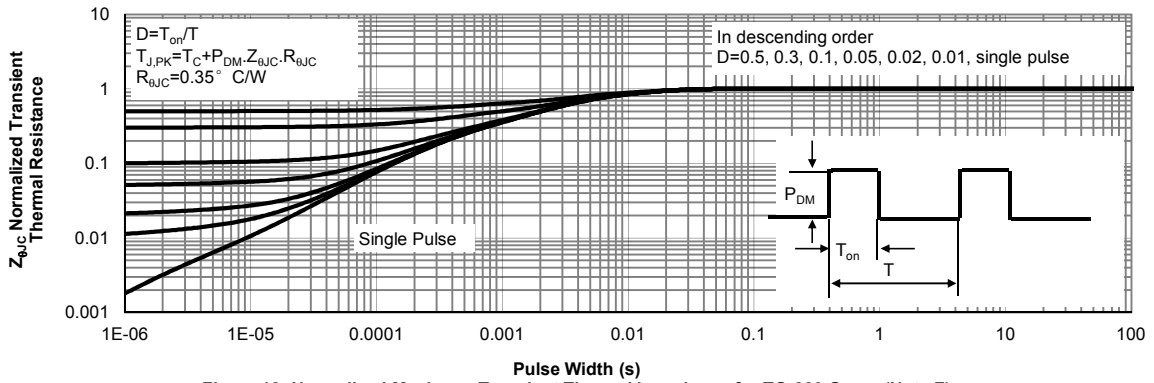
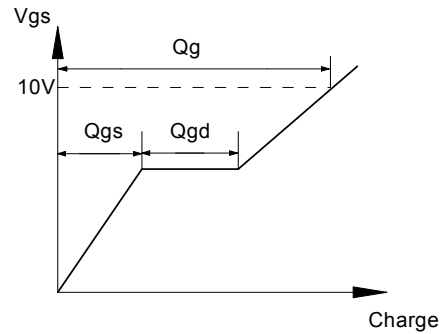
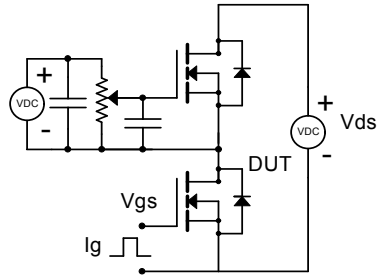
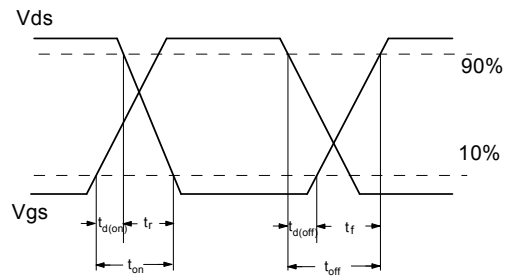
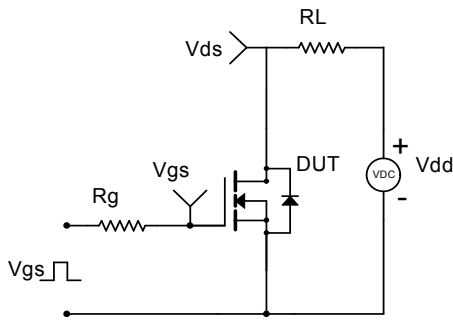

Figure 12: Normalized Maximum Transient Thermal Impedance for TO-220 Green (Note F)

Gate Charge Test Circuit & Waveform



Resistive Switching Test Circuit & Waveforms



Unclamped Inductive Switching (UIS) Test Circuit & Waveforms

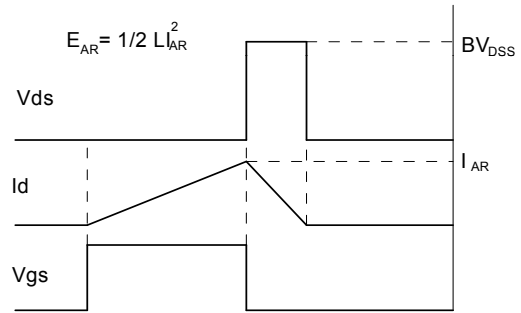
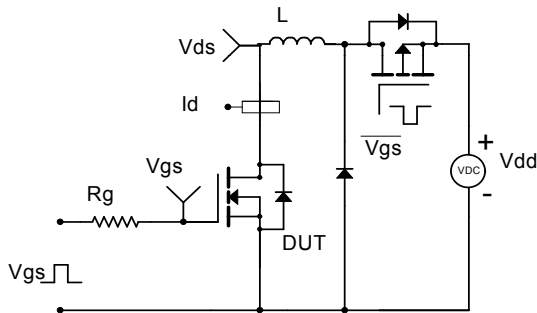

Diode Recovery Test Circuit & Waveforms

