

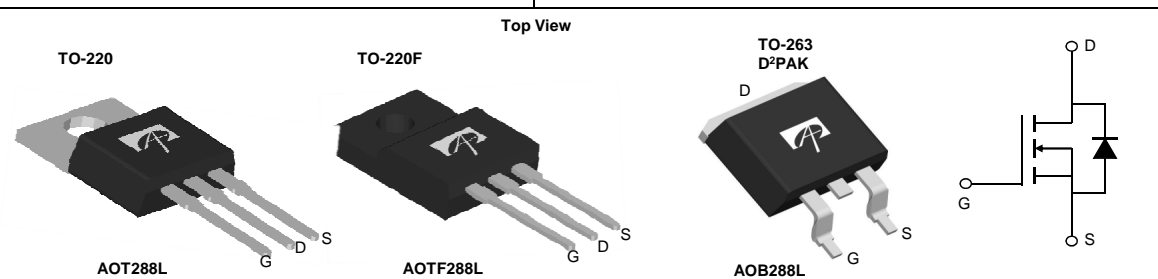
**General Description**

The AOT288L & AOB288L & AOTF288L uses trench MOSFET technology that is uniquely optimized to provide the most efficient high frequency switching performance. Both conduction and switching power losses are minimized due to an extremely low combination of  $R_{DS(ON)}$ ,  $C_{iss}$  and  $C_{oss}$ . This device is ideal for boost converters and synchronous rectifiers for consumer, telecom, industrial power supplies and LED backlighting.

**Product Summary**

$V_{DS}$	80V
$I_D$ (at $V_{GS}=10V$ )	46A / 43A
$R_{DS(ON)}$ (at $V_{GS}=10V$ )	< 9.2m $\Omega$ (< 8.9m $\Omega^*$ )
$R_{DS(ON)}$ (at $V_{GS}=6V$ )	< 12.5m $\Omega$ (< 12.2m $\Omega^*$ )

100% UIS Tested  
 100%  $R_g$  Tested


**Absolute Maximum Ratings  $T_A=25^\circ C$  unless otherwise noted**

Parameter	Symbol	AOT288L/AOB288L	AOTF288L	Units
Drain-Source Voltage	$V_{DS}$	80		V
Gate-Source Voltage	$V_{GS}$	$\pm 20$		V
Continuous Drain Current <sup>G</sup>	$I_D$	$T_C=25^\circ C$	46	43
		$T_C=100^\circ C$	36	30
Pulsed Drain Current <sup>C</sup>	$I_{DM}$	160		A
Continuous Drain Current	$I_{DSM}$	$T_A=25^\circ C$	10.5	A
		$T_A=70^\circ C$	8	
Avalanche Current <sup>C</sup>	$I_{AS}$	35		A
Avalanche energy $L=0.1mH$ <sup>C</sup>	$E_{AS}$	61		mJ
Power Dissipation <sup>B</sup>	$P_D$	$T_C=25^\circ C$	93.5	35.5
		$T_C=100^\circ C$	46.5	17.5
Power Dissipation <sup>A</sup>	$P_{DSM}$	$T_A=25^\circ C$	2.1	
		$T_A=70^\circ C$	1.3	
Junction and Storage Temperature Range	$T_J, T_{STG}$	-55 to 175		$^\circ C$

**Thermal Characteristics**

Parameter	Symbol	AOT288L/AOB288L	AOTF288L	Units
Maximum Junction-to-Ambient <sup>A</sup>	$R_{\theta JA}$	$t \leq 10s$	15	15
Maximum Junction-to-Ambient <sup>A,D</sup>		Steady-State	60	60
Maximum Junction-to-Case	$R_{\theta JC}$	1.6	4.2	$^\circ C/W$

\* Surface mount package TO263

**Electrical Characteristics (T<sub>J</sub>=25°C unless otherwise noted)**

Symbol	Parameter	Conditions	Min	Typ	Max	Units
<b>STATIC PARAMETERS</b>						
BV <sub>DSS</sub>	Drain-Source Breakdown Voltage	I <sub>D</sub> =250μA, V <sub>GS</sub> =0V	80			V
I <sub>DSS</sub>	Zero Gate Voltage Drain Current	V <sub>DS</sub> =80V, V <sub>GS</sub> =0V T <sub>J</sub> =55°C			1 5	μA
I <sub>GSS</sub>	Gate-Body leakage current	V <sub>DS</sub> =0V, V <sub>GS</sub> =±20V			±100	nA
V <sub>GS(th)</sub>	Gate Threshold Voltage	V <sub>DS</sub> =V <sub>GS</sub> , I <sub>D</sub> =250μA	2.3	2.8	3.4	V
I <sub>D(ON)</sub>	On state drain current	V <sub>GS</sub> =10V, V <sub>DS</sub> =5V	160			A
R <sub>DS(ON)</sub>	Static Drain-Source On-Resistance	V <sub>GS</sub> =10V, I <sub>D</sub> =20A TO220/TO220F T <sub>J</sub> =125°C		7.6	9.2	mΩ
		V <sub>GS</sub> =6V, I <sub>D</sub> =20A TO220/TO220F		9.5	12.5	
		V <sub>GS</sub> =10V, I <sub>D</sub> =20A TO263		7.3	8.9	mΩ
		V <sub>GS</sub> =6V, I <sub>D</sub> =20A TO263		9.2	12.2	mΩ
g <sub>FS</sub>	Forward Transconductance	V <sub>DS</sub> =5V, I <sub>D</sub> =20A		50		S
V <sub>SD</sub>	Diode Forward Voltage	I <sub>S</sub> =1A, V <sub>GS</sub> =0V		0.71	1	V
I <sub>S</sub>	Maximum Body-Diode Continuous Current <sup>G</sup>				46	A
<b>DYNAMIC PARAMETERS</b>						
C <sub>iss</sub>	Input Capacitance	V <sub>GS</sub> =0V, V <sub>DS</sub> =40V, f=1MHz		1871		pF
C <sub>oss</sub>	Output Capacitance			265		pF
C <sub>rss</sub>	Reverse Transfer Capacitance			14		pF
R <sub>g</sub>	Gate resistance	V <sub>GS</sub> =0V, V <sub>DS</sub> =0V, f=1MHz	0.6	1.3	2	Ω
<b>SWITCHING PARAMETERS</b>						
Q <sub>g(10V)</sub>	Total Gate Charge	V <sub>GS</sub> =10V, V <sub>DS</sub> =40V, I <sub>D</sub> =20A		26.5	38	nC
Q <sub>gs</sub>	Gate Source Charge			8.5		nC
Q <sub>gd</sub>	Gate Drain Charge			4		nC
t <sub>D(on)</sub>	Turn-On Delay Time	V <sub>GS</sub> =10V, V <sub>DS</sub> =40V, R <sub>L</sub> =2Ω, R <sub>GEN</sub> =3Ω		11.5		ns
t <sub>r</sub>	Turn-On Rise Time			8.5		ns
t <sub>D(off)</sub>	Turn-Off Delay Time			21.5		ns
t <sub>f</sub>	Turn-Off Fall Time			5.5		ns
t <sub>rr</sub>	Body Diode Reverse Recovery Time	I <sub>F</sub> =20A, di/dt=500A/μs		32		ns
Q <sub>rr</sub>	Body Diode Reverse Recovery Charge	I <sub>F</sub> =20A, di/dt=500A/μs		162		nC

A. The value of R<sub>θJA</sub> is measured with the device mounted on 1in<sup>2</sup> FR-4 board with 2oz. Copper, in a still air environment with T<sub>A</sub>=25° C. The Power dissipation P<sub>DSM</sub> is based on R<sub>θJA</sub> and the maximum allowed junction temperature of 150° C. The value in any given application depends on the user's specific board design, and the maximum temperature of 175° C may be used if the PCB allows it.

B. The power dissipation P<sub>D</sub> is based on T<sub>J(MAX)</sub>=175° C, using junction-to-case thermal resistance, and is more useful in setting the upper dissipation limit for cases where additional heatsinking is used.

C. Repetitive rating, pulse width limited by junction temperature T<sub>J(MAX)</sub>=175° C. Ratings are based on low frequency and duty cycles to keep initial T<sub>J</sub>=25° C.

D. The R<sub>θJA</sub> is the sum of the thermal impedance from junction to case R<sub>θJC</sub> and case to ambient.

E. The static characteristics in Figures 1 to 6 are obtained using <300μs pulses, duty cycle 0.5% max.

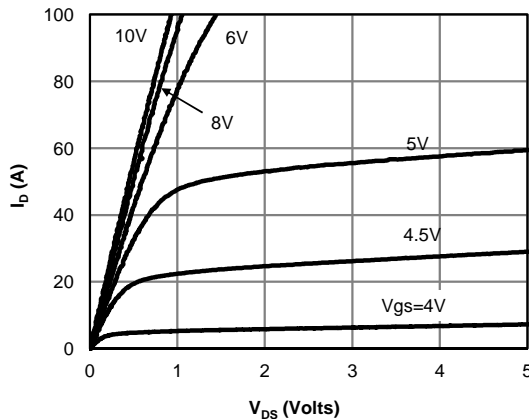
F. These curves are based on the junction-to-case thermal impedance which is measured with the device mounted to a large heatsink, assuming a maximum junction temperature of T<sub>J(MAX)</sub>=175° C. The SOA curve provides a single pulse rating.

G. The maximum current limited by package.

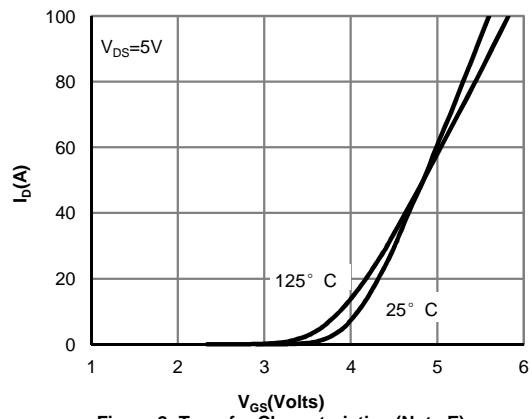
H. These tests are performed with the device mounted on 1 in<sup>2</sup> FR-4 board with 2oz. Copper, in a still air environment with T<sub>A</sub>=25° C.

THIS PRODUCT HAS BEEN DESIGNED AND QUALIFIED FOR THE CONSUMER MARKET. APPLICATIONS OR USES AS CRITICAL COMPONENTS IN LIFE SUPPORT DEVICES OR SYSTEMS ARE NOT AUTHORIZED. AOS DOES NOT ASSUME ANY LIABILITY ARISING OUT OF SUCH APPLICATIONS OR USES OF ITS PRODUCTS. AOS RESERVES THE RIGHT TO IMPROVE PRODUCT DESIGN, FUNCTIONS AND RELIABILITY WITHOUT NOTICE.

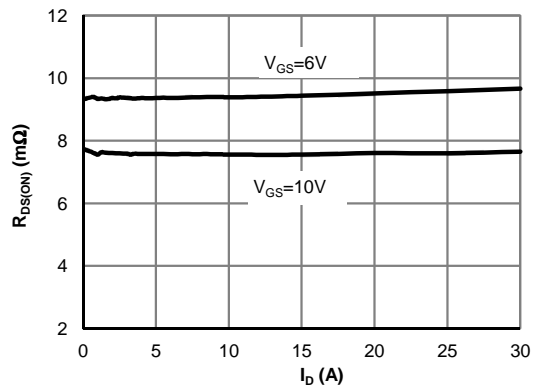
**TYPICAL ELECTRICAL AND THERMAL CHARACTERISTICS**



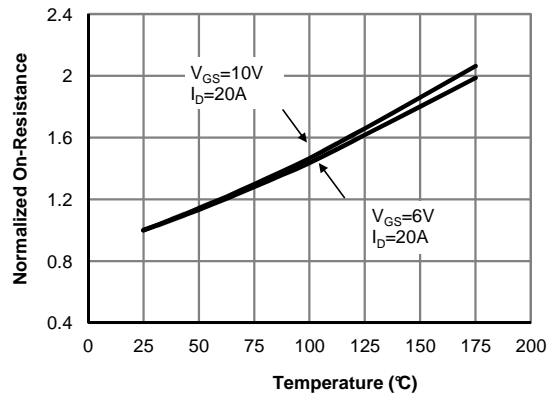
**Figure 1: On-Region Characteristics (Note E)**



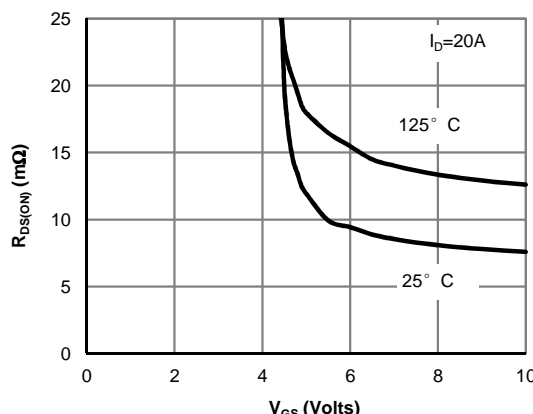
**Figure 2: Transfer Characteristics (Note E)**



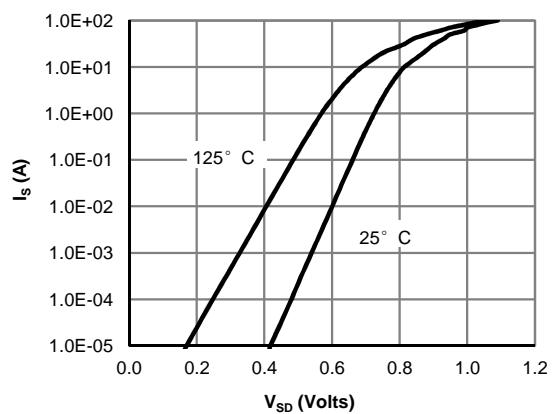
**Figure 3: On-Resistance vs. Drain Current and Gate Voltage (Note E)**



**Figure 4: On-Resistance vs. Junction Temperature (Note E)**

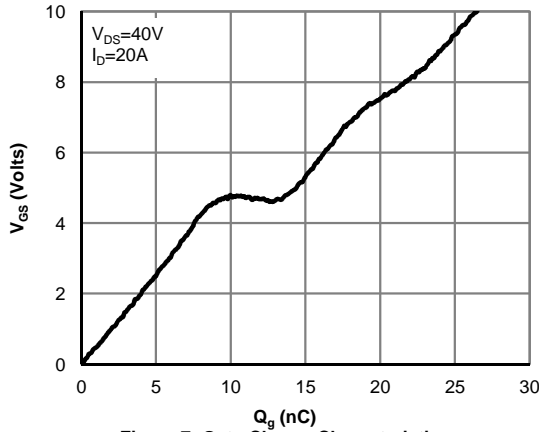


**Figure 5: On-Resistance vs. Gate-Source Voltage (Note E)**

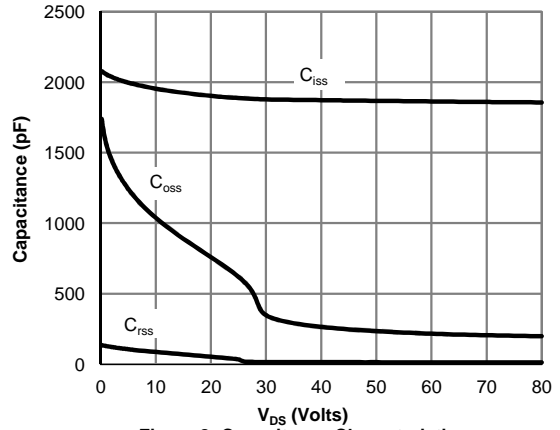


**Figure 6: Body-Diode Characteristics (Note E)**

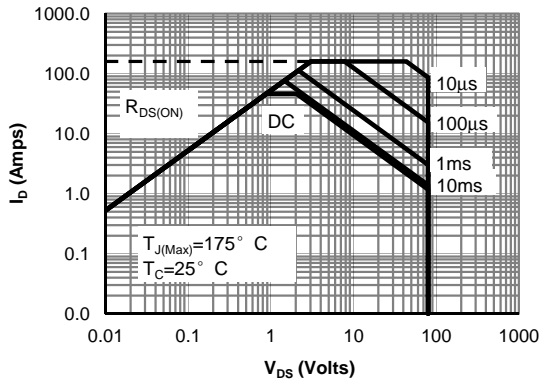
**TYPICAL ELECTRICAL AND THERMAL CHARACTERISTICS**



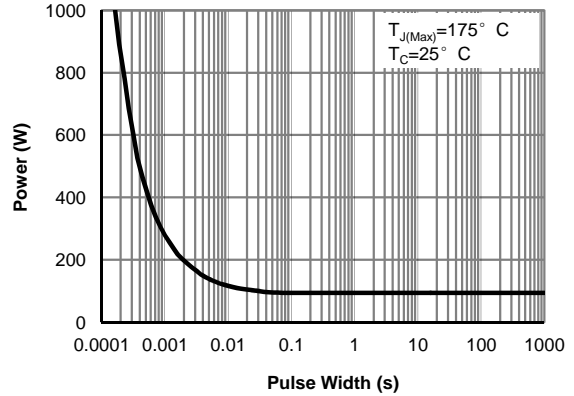
**Figure 7: Gate-Charge Characteristics**



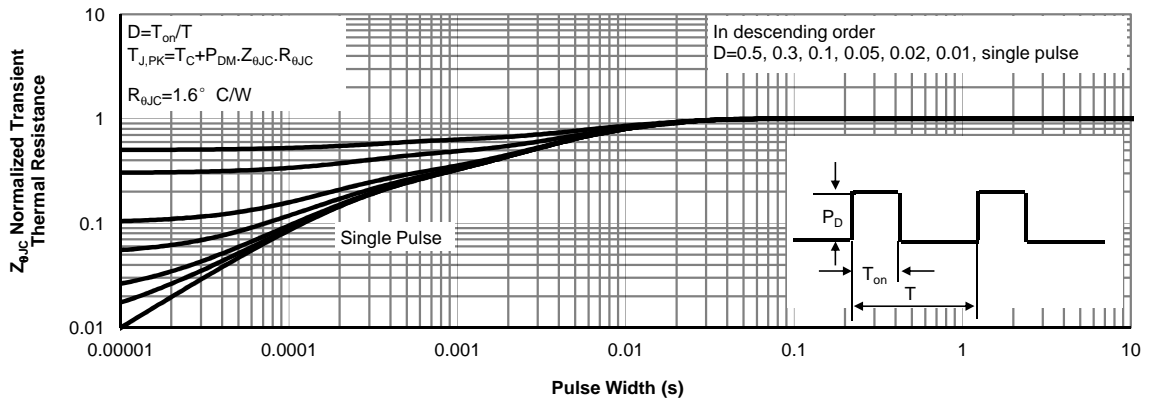
**Figure 8: Capacitance Characteristics**



**Figure 9: Maximum Forward Biased Safe Operating Area for AOT288L and AOB288L (Note F)**

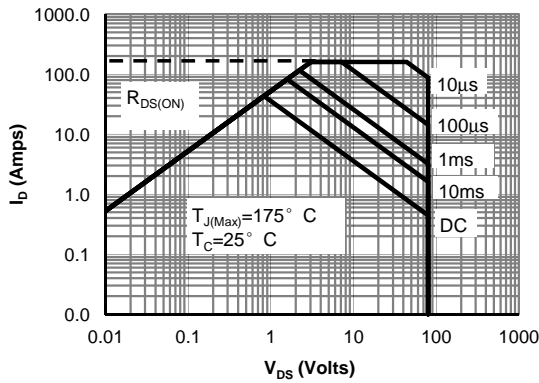


**Figure 10: Single Pulse Power Rating Junction-to-Case for AOT288L and AOB288L (Note F)**

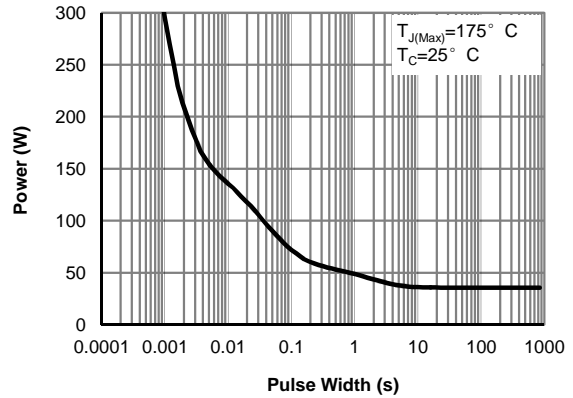


**Figure 11: Normalized Maximum Transient Thermal Impedance for AOT288L and AOB288L (Note F)**

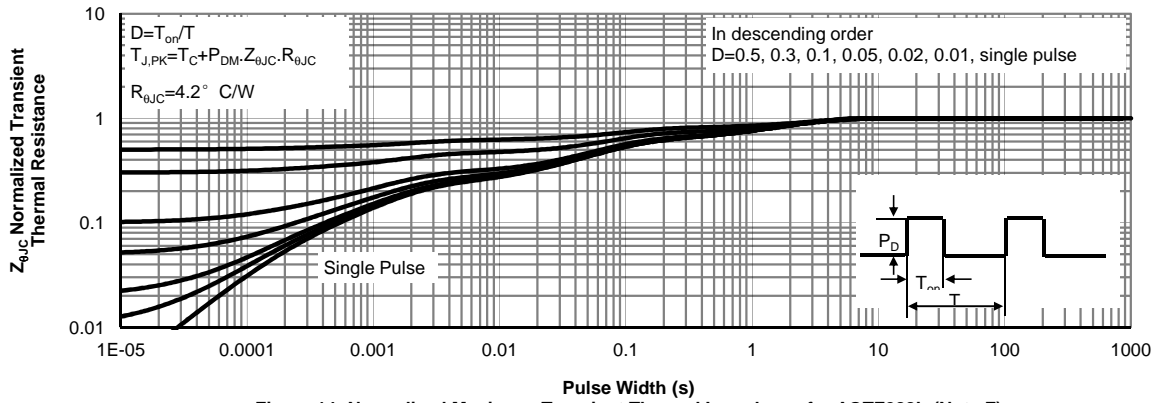
**TYPICAL ELECTRICAL AND THERMAL CHARACTERISTICS**



**Figure 12: Maximum Forward Biased Safe Operating Area for AOTF288L**

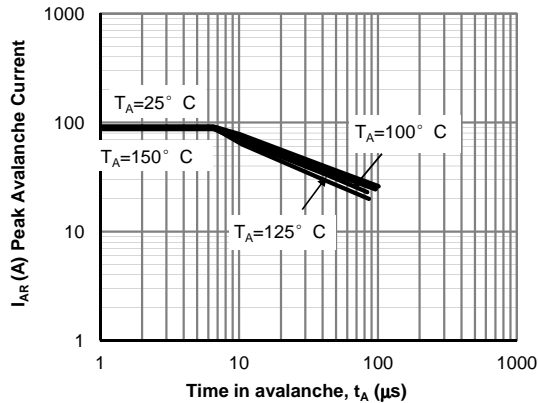


**Figure 13: Single Pulse Power Rating Junction-to-Case for AOTF288L (Note F)**

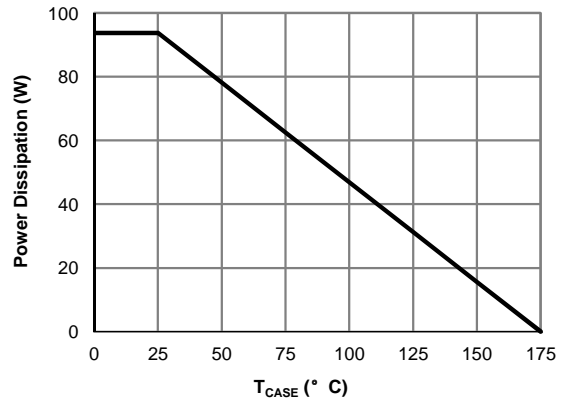


**Figure 14: Normalized Maximum Transient Thermal Impedance for AOTF288L (Note F)**

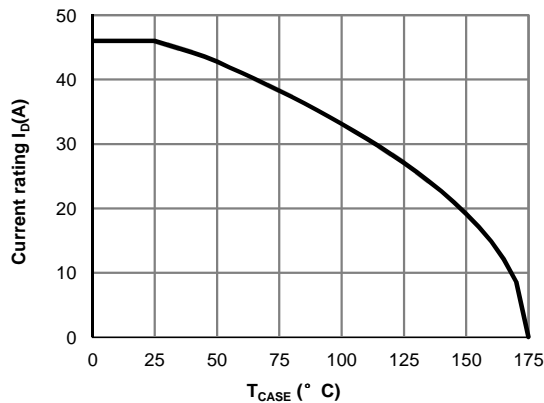
**TYPICAL ELECTRICAL AND THERMAL CHARACTERISTICS**



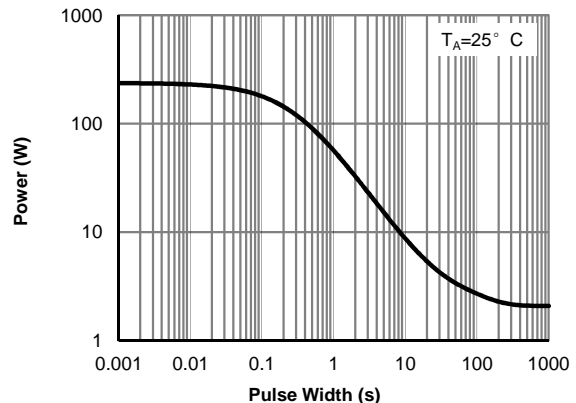
**Figure 15: Single Pulse Avalanche capability (Note C)**



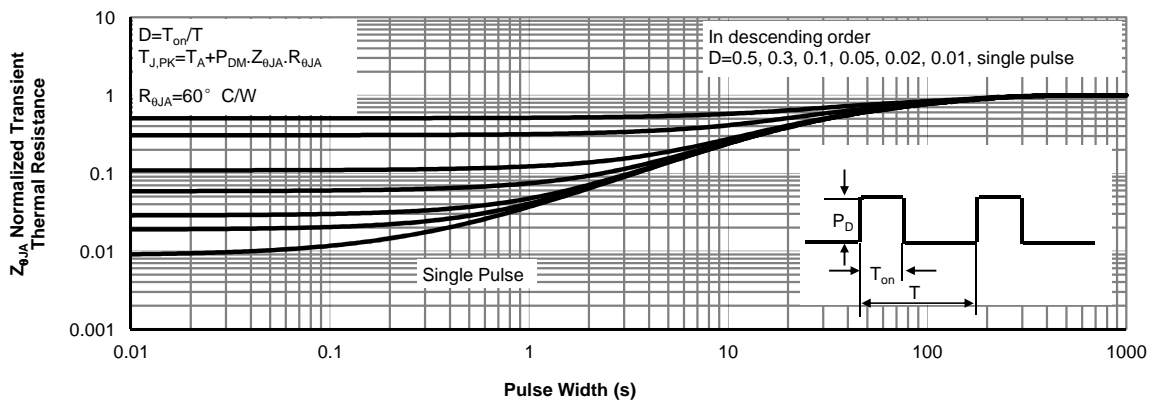
**Figure 16: Power De-rating (Note F)**



**Figure 17: Current De-rating (Note F)**

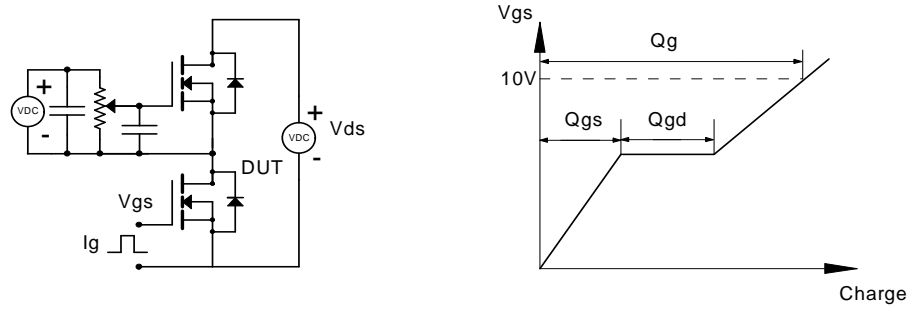


**Figure 18: Single Pulse Power Rating Junction-to-Ambient (Note H)**

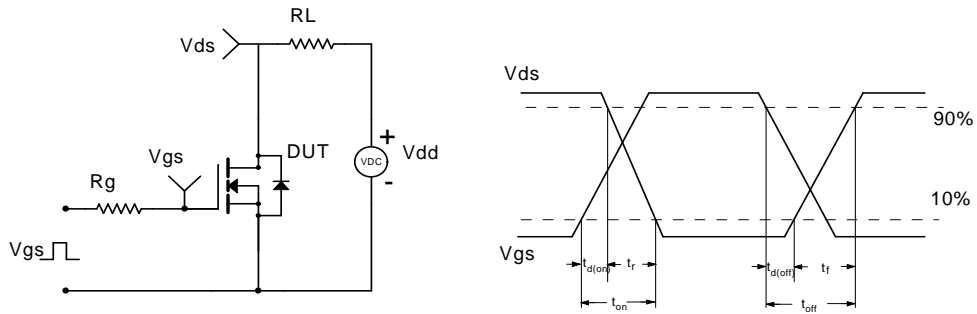


**Figure 19: Normalized Maximum Transient Thermal Impedance (Note H)**

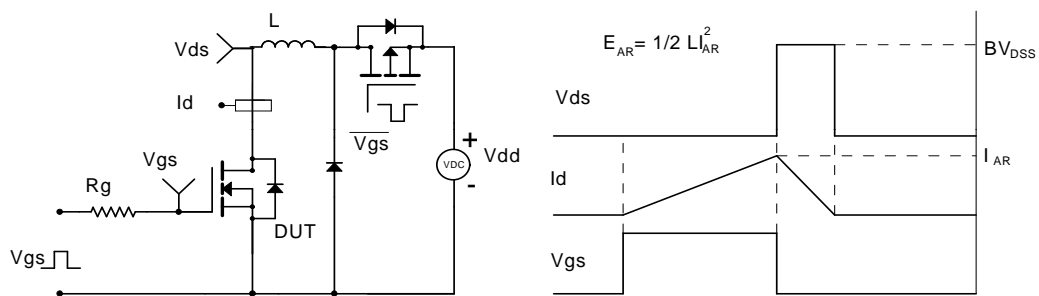
**Gate Charge Test Circuit & Waveform**



**Resistive Switching Test Circuit & Waveforms**



**Unclamped Inductive Switching (UIS) Test Circuit & Waveforms**



**Diode Recovery Test Circuit & Waveforms**

