

**General Description**

The AOTF3N90 has been fabricated using an advanced high voltage MOSFET process that is designed to deliver high levels of performance and robustness in popular AC-DC applications. By providing low  $R_{DS(on)}$ ,  $C_{iss}$  and  $C_{riss}$  along with guaranteed avalanche capability this part can be adopted quickly into new and existing offline power supply designs.

For Halogen Free add "L" suffix to part number:  
 AOTF3N90L

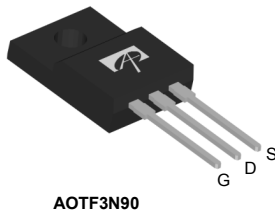
**Product Summary**

$V_{DS}$	1000V@150°C
$I_D$ (at $V_{GS}=10V$ )	2.4A
$R_{DS(ON)}$ (at $V_{GS}=10V$ )	< 6.7Ω

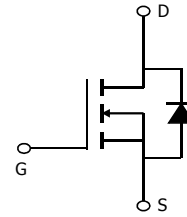
100% UIS Tested  
 100%  $R_g$  Tested



Top View  
 TO-220F



AOTF3N90


**Absolute Maximum Ratings  $T_A=25^\circ\text{C}$  unless otherwise noted**

Parameter	Symbol	AOTF3N90	Units
Drain-Source Voltage	$V_{DS}$	900	V
Gate-Source Voltage	$V_{GS}$	±30	V
Continuous Drain Current	$I_D$	$T_C=25^\circ\text{C}$	2.4*
		$T_C=100^\circ\text{C}$	1.5*
Pulsed Drain Current <sup>C</sup>	$I_{DM}$	6.7	A
Avalanche Current <sup>C</sup>	$I_{AR}$	2	A
Repetitive avalanche energy <sup>C</sup>	$E_{AR}$	60	mJ
Single pulsed avalanche energy <sup>G</sup>	$E_{AS}$	120	mJ
Peak diode recovery dv/dt	dv/dt	5	V/ns
Power Dissipation <sup>B</sup>	$P_D$	$T_C=25^\circ\text{C}$	35
		Derate above 25°C	0.3
Junction and Storage Temperature Range	$T_J, T_{STG}$	-55 to 150	°C
Maximum lead temperature for soldering purpose, 1/8" from case for 5 seconds	$T_L$	300	°C

**Thermal Characteristics**

Parameter	Symbol	AOTF3N90	Units
Maximum Junction-to-Ambient <sup>A,D</sup>	$R_{\theta JA}$	65	°C/W
Maximum Junction-to-Case	$R_{\theta JC}$	3.6	°C/W

\* Drain current limited by maximum junction temperature.

**Electrical Characteristics (T<sub>J</sub>=25°C unless otherwise noted)**

Symbol	Parameter	Conditions	Min	Typ	Max	Units	
<b>STATIC PARAMETERS</b>							
BV <sub>DSS</sub>	Drain-Source Breakdown Voltage	I <sub>D</sub> =250μA, V <sub>GS</sub> =0V, T <sub>J</sub> =25°C	900			V	
		I <sub>D</sub> =250μA, V <sub>GS</sub> =0V, T <sub>J</sub> =150°C		1000			
BV <sub>DSS</sub> /ΔT <sub>J</sub>	Breakdown Voltage Temperature Coefficient	I <sub>D</sub> =250μA, V <sub>GS</sub> =0V		0.85		V/°C	
I <sub>DSS</sub>	Zero Gate Voltage Drain Current	V <sub>DS</sub> =900V, V <sub>GS</sub> =0V			1	μA	
		V <sub>DS</sub> =720V, T <sub>J</sub> =125°C			10		
I <sub>GSS</sub>	Gate-Body leakage current	V <sub>DS</sub> =0V, V <sub>GS</sub> =±30V			±100	nA	
V <sub>GS(th)</sub>	Gate Threshold Voltage	V <sub>DS</sub> =5V, I <sub>D</sub> =250μA	3.6	4.2	4.5	V	
R <sub>DS(ON)</sub>	Static Drain-Source On-Resistance	V <sub>GS</sub> =10V, I <sub>D</sub> =1.5A		5.5	6.7	Ω	
g <sub>FS</sub>	Forward Transconductance	V <sub>DS</sub> =40V, I <sub>D</sub> =1.5A		3		S	
V <sub>SD</sub>	Diode Forward Voltage	I <sub>S</sub> =1A, V <sub>GS</sub> =0V		0.77	1	V	
I <sub>S</sub>	Maximum Body-Diode Continuous Current				2.4	A	
I <sub>SM</sub>	Maximum Body-Diode Pulsed Current				6.7	A	
<b>DYNAMIC PARAMETERS</b>							
C <sub>iss</sub>	Input Capacitance	V <sub>GS</sub> =0V, V <sub>DS</sub> =25V, f=1MHz	350	444	540	pF	
C <sub>oss</sub>	Output Capacitance		22	34	45	pF	
C <sub>rss</sub>	Reverse Transfer Capacitance		1.7	3.3	4.7	pF	
R <sub>g</sub>	Gate resistance	V <sub>GS</sub> =0V, V <sub>DS</sub> =0V, f=1MHz	1.2	2.6	4.0	Ω	
<b>SWITCHING PARAMETERS</b>							
Q <sub>g</sub>	Total Gate Charge	V <sub>GS</sub> =10V, V <sub>DS</sub> =720V, I <sub>D</sub> =3A	6	11	16	nC	
Q <sub>gs</sub>	Gate Source Charge				2.7		nC
Q <sub>gd</sub>	Gate Drain Charge				4.1		nC
t <sub>D(on)</sub>	Turn-On DelayTime	V <sub>GS</sub> =10V, V <sub>DS</sub> =450V, I <sub>D</sub> =3A, R <sub>G</sub> =25Ω		19		ns	
t <sub>r</sub>	Turn-On Rise Time			28		ns	
t <sub>D(off)</sub>	Turn-Off DelayTime			42		ns	
t <sub>f</sub>	Turn-Off Fall Time			24		ns	
t <sub>rr</sub>	Body Diode Reverse Recovery Time	I <sub>F</sub> =3A, di/dt=100A/μs, V <sub>DS</sub> =100V	520	655	790	ns	
Q <sub>rr</sub>	Body Diode Reverse Recovery Charge	I <sub>F</sub> =3A, di/dt=100A/μs, V <sub>DS</sub> =100V	5	7	9	μC	

A. The value of R<sub>θJA</sub> is measured with the device in a still air environment with T<sub>A</sub>=25°C.

B. The power dissipation P<sub>D</sub> is based on T<sub>J(MAX)</sub>=150°C, using junction-to-case thermal resistance, and is more useful in setting the upper dissipation limit for cases where additional heatsinking is used.

C. Repetitive rating, pulse width limited by junction temperature T<sub>J(MAX)</sub>=150°C. Ratings are based on low frequency and duty cycles to keep initial T<sub>J</sub>=25°C.

D. The R<sub>θJA</sub> is the sum of the thermal impedance from junction to case R<sub>θJC</sub> and case to ambient.

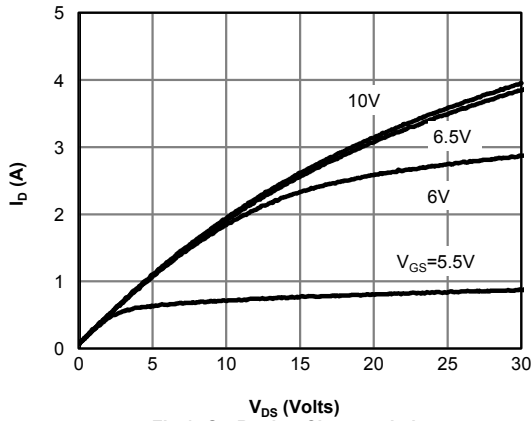
E. The static characteristics in Figures 1 to 6 are obtained using <300 μs pulses, duty cycle 0.5% max.

F. These curves are based on the junction-to-case thermal impedance which is measured with the device mounted to a large heatsink, assuming a maximum junction temperature of T<sub>J(MAX)</sub>=150°C. The SOA curve provides a single pulse rating.

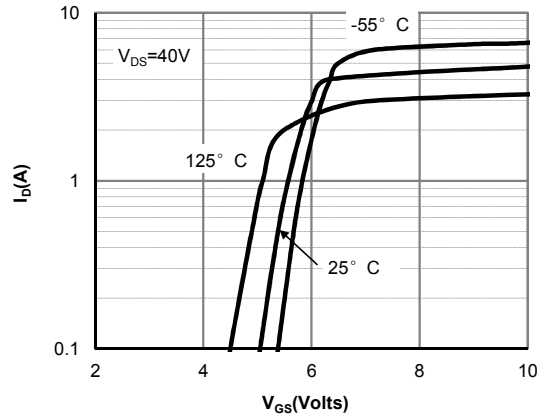
G. L=60mH, I<sub>AS</sub>=2A, V<sub>DD</sub>=150V, R<sub>G</sub>=25Ω, Starting T<sub>J</sub>=25°C

THIS PRODUCT HAS BEEN DESIGNED AND QUALIFIED FOR THE CONSUMER MARKET. APPLICATIONS OR USES AS CRITICAL COMPONENTS IN LIFE SUPPORT DEVICES OR SYSTEMS ARE NOT AUTHORIZED. AOS DOES NOT ASSUME ANY LIABILITY ARISING OUT OF SUCH APPLICATIONS OR USES OF ITS PRODUCTS. AOS RESERVES THE RIGHT TO IMPROVE PRODUCT DESIGN, FUNCTIONS AND RELIABILITY WITHOUT NOTICE.

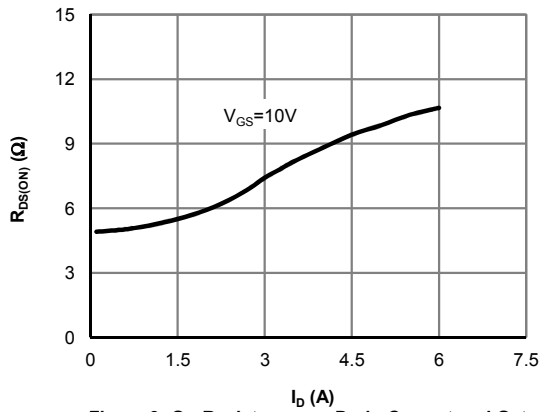
**TYPICAL ELECTRICAL AND THERMAL CHARACTERISTICS**



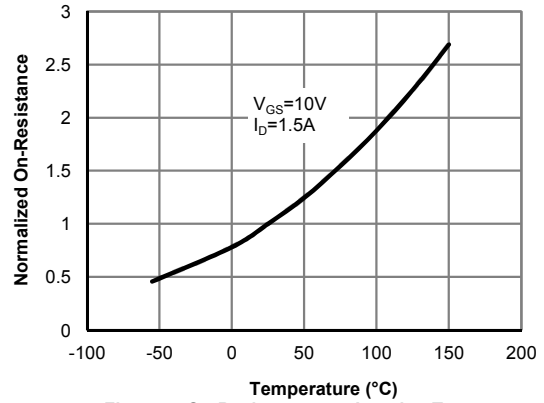
**Fig 1: On-Region Characteristics**



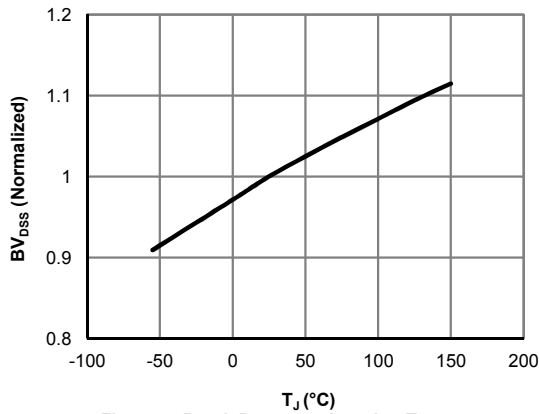
**Figure 2: Transfer Characteristics**



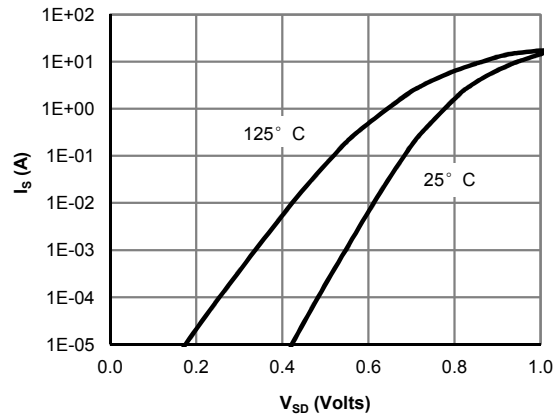
**Figure 3: On-Resistance vs. Drain Current and Gate Voltage**



**Figure 4: On-Resistance vs. Junction Temperature**

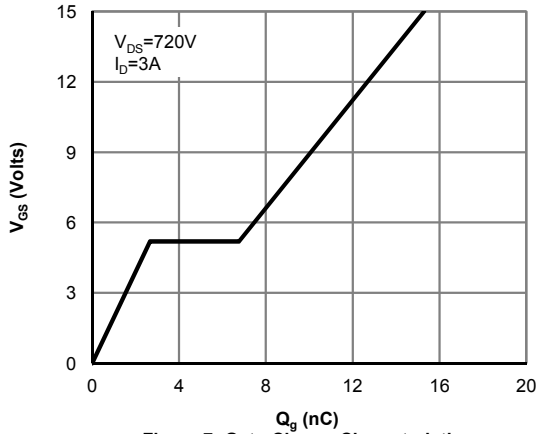


**Figure 5: Break Down vs. Junction Temperature**

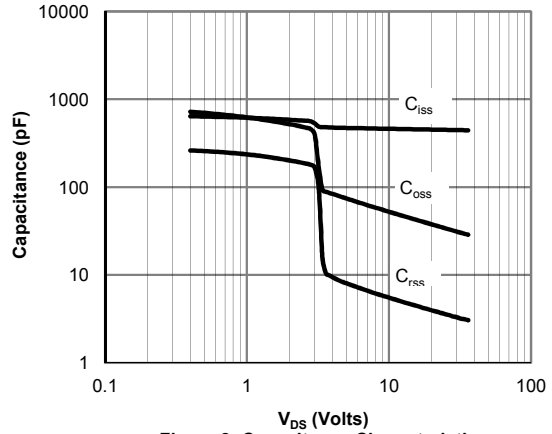


**Figure 6: Body-Diode Characteristics (Note E)**

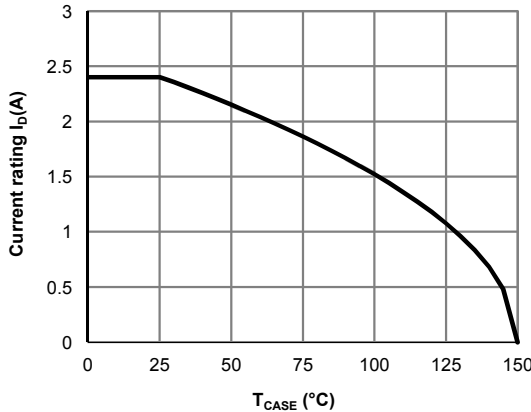
**TYPICAL ELECTRICAL AND THERMAL CHARACTERISTICS**



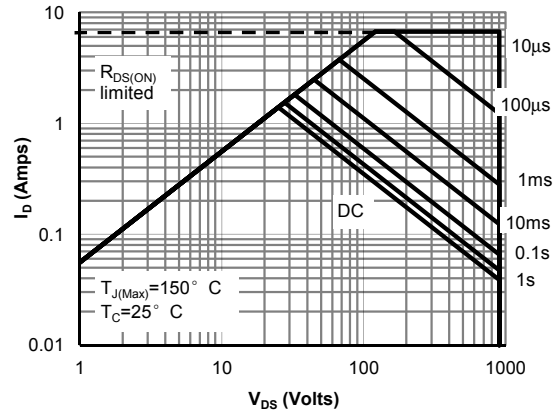
**Figure 7: Gate-Charge Characteristics**



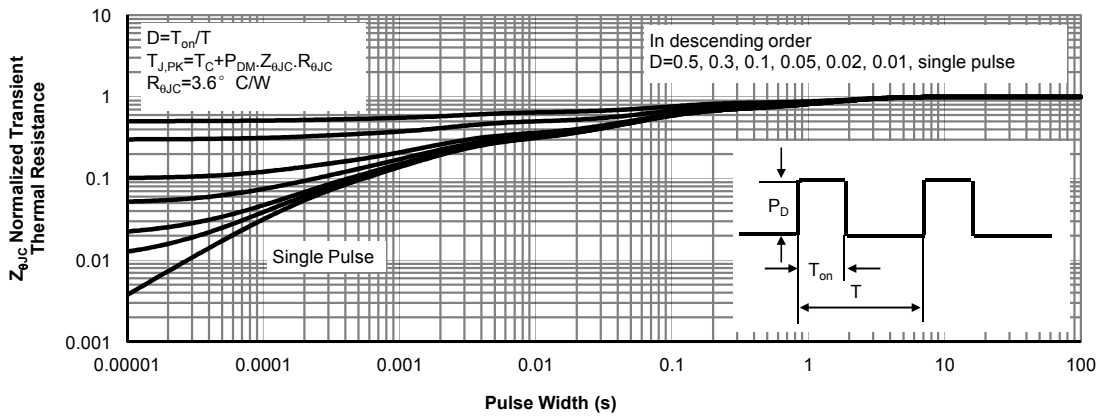
**Figure 8: Capacitance Characteristics**



**Figure 9: Current De-rating (Note B)**

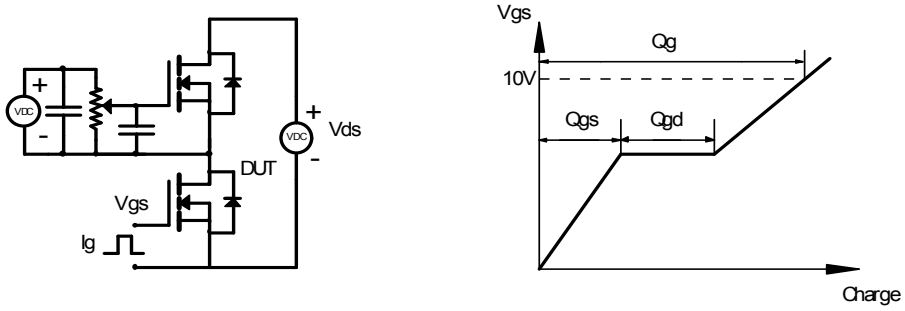


**Figure 10: Maximum Forward Biased Safe Operating Area for AOTF3N90 (Note F)**

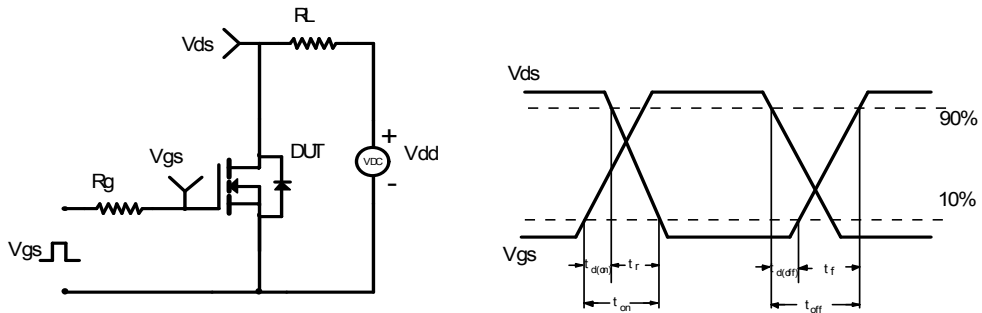


**Figure 11: Normalized Maximum Transient Thermal Impedance for AOTF3N90 (Note F)**

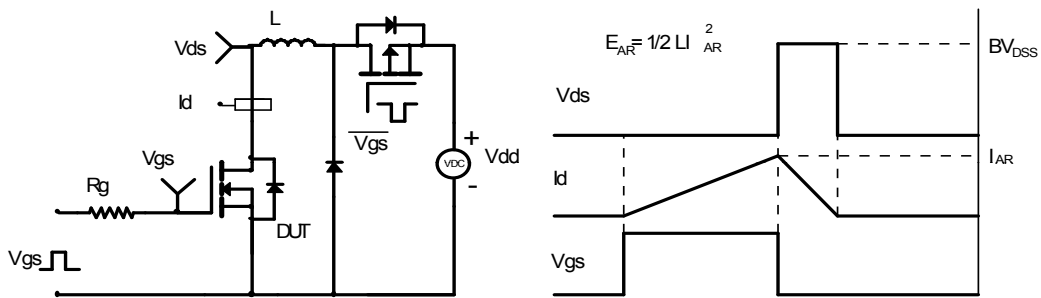
Gate Charge Test Circuit & Waveform



Resistive Switching Test Circuit & Waveforms



Unclamped Inductive Switching (UIS) Test Circuit & Waveforms



Diode Recovery Test Circuit & Waveforms

