

General Description

- Low $R_{DS(ON)}$
- RoHS and Halogen-Free Compliant

Applications

- Load switch
- PWM

Features

$V_{DS} = 30V$
 $I_D = 5.8A$ ($V_{GS} = 10V$)
 $R_{DS(ON)} < 25m\Omega$ ($V_{GS} = 10V$)
 $R_{DS(ON)} < 35m\Omega$ ($V_{GS} = 4.5V$)

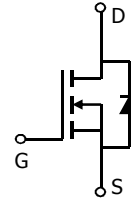
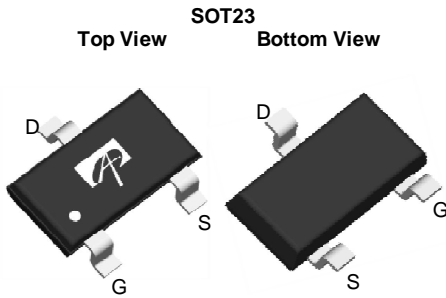

Absolute Maximum Ratings $T_A=25^\circ C$ unless otherwise noted

Parameter	Symbol	Maximum	Units
Drain-Source Voltage	V_{DS}	30	V
Gate-Source Voltage	V_{GS}	± 20	V
Continuous Drain Current ^{A,F}	I_D	$T_A=25^\circ C$	A
		$T_A=70^\circ C$	
Pulsed Drain Current ^B	I_{DM}	64	
Power Dissipation	P_D	$T_A=25^\circ C$	W
		$T_A=70^\circ C$	
Junction and Storage Temperature Range	T_J, T_{STG}	-55 to 150	$^\circ C$

Thermal Characteristics

Parameter	Symbol	Typ	Max	Units
Maximum Junction-to-Ambient ^A	$R_{\theta JA}$	65	90	$^\circ C/W$
$t \leq 10s$				
Maximum Junction-to-Ambient ^A	$R_{\theta JL}$	63	80	$^\circ C/W$
Steady-State				
Maximum Junction-to-Lead ^C				

Electrical Characteristics (T_J=25°C unless otherwise noted)

Symbol	Parameter	Conditions	Min	Typ	Max	Units
STATIC PARAMETERS						
BV _{DSS}	Drain-Source Breakdown Voltage	I _D =250μA, V _{GS} =0V	30			V
I _{DSS}	Zero Gate Voltage Drain Current	V _{DS} =30V, V _{GS} =0V T _J =55°C			1 5	μA
I _{GSS}	Gate-Body leakage current	V _{DS} =0V, V _{GS} = ±20V			100	nA
V _{GS(th)}	Gate Threshold Voltage	V _{DS} =V _{GS} I _D =250μA	1.5	2.1	2.6	V
I _{D(ON)}	On state drain current	V _{GS} =4.5V, V _{DS} =5V	64			A
R _{DS(ON)}	Static Drain-Source On-Resistance	V _{GS} =10V, I _D =5.8A T _J =125°C		18.4 26.2	25 36	mΩ
		V _{GS} =4.5V, I _D =4.8A		24.5	35	mΩ
g _{FS}	Forward Transconductance	V _{DS} =5V, I _D =5.8A		22		S
V _{SD}	Diode Forward Voltage	I _S =1A, V _{GS} =0V		0.75	1	V
I _S	Maximum Body-Diode Continuous Current				2.5	A
DYNAMIC PARAMETERS						
C _{iss}	Input Capacitance	V _{GS} =0V, V _{DS} =15V, f=1MHz		373		pF
C _{oss}	Output Capacitance			67		pF
C _{rss}	Reverse Transfer Capacitance			41		pF
R _g	Gate resistance	V _{GS} =0V, V _{DS} =0V, f=1MHz	0.9	1.8	2.8	Ω
SWITCHING PARAMETERS						
Q _g (10V)	Total Gate Charge	V _{GS} =10V, V _{DS} =15V, I _D =5.8A		7.1	18	nC
Q _g (4.5V)	Total Gate Charge			3.3		nC
Q _{gs}	Gate Source Charge			1.4		nC
Q _{gd}	Gate Drain Charge			1.7		nC
t _{D(on)}	Turn-On DelayTime	V _{GS} =10V, V _{DS} =15V, R _L =2.6Ω, R _{GEN} =3Ω		4.5		ns
t _r	Turn-On Rise Time			2.4		ns
t _{D(off)}	Turn-Off DelayTime			14.8		ns
t _f	Turn-Off Fall Time			2.5		ns
t _{rr}	Body Diode Reverse Recovery Time	I _F =5.8A, di/dt=100A/μs		10.5		ns
Q _{rr}	Body Diode Reverse Recovery Charge	I _F =5.8A, di/dt=100A/μs		4.5		nC

A: The value of R_{θJA} is measured with the device mounted on 1in² FR-4 board with 2oz. Copper, in a still air environment with T_A=25° C. The value in any given application depends on the user's specific board design. The current rating is based on the t ≤ 10s thermal resistance rating.

B: Repetitive rating, pulse width limited by junction temperature.

C: The R_{θJA} is the sum of the thermal impedance from junction to lead R_{θJL} and lead to ambient.

D: The static characteristics in Figures 1 to 6 are obtained using <300 μs pulses, duty cycle 0.5% max.

E: These tests are performed with the device mounted on 1 in² FR-4 board with 2oz. Copper, in a still air environment with T_A=25° C. The SOA curve provides a single pulse rating.

F: The current rating is based on the t ≤ 10s thermal resistance rating.

APPLICATIONS OR USE AS CRITICAL COMPONENTS IN LIFE SUPPORT DEVICES OR SYSTEMS ARE NOT AUTHORIZED. AOS DOES NOT ASSUME ANY LIABILITY ARISING OUT OF SUCH APPLICATIONS OR USES OF ITS PRODUCTS. AOS RESERVES THE RIGHT TO IMPROVE PRODUCT DESIGN,FUNCTIONS AND RELIABILITY WITHOUT NOTICE.

TYPICAL ELECTRICAL AND THERMAL CHARACTERISTICS

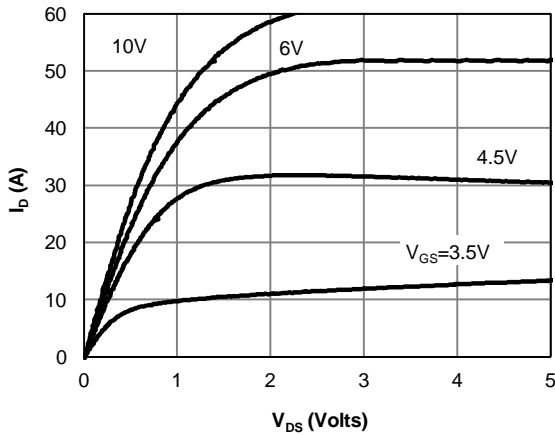

Figure 1: On-Region Characteristics

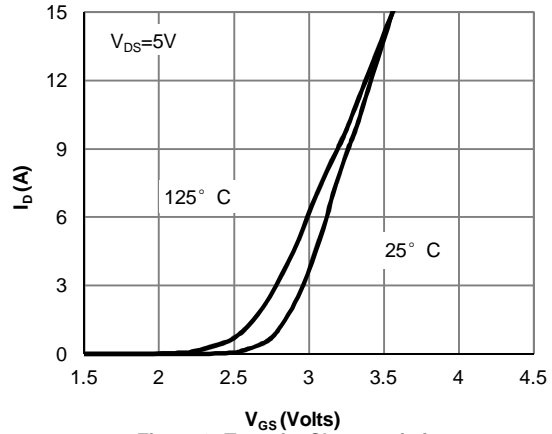

Figure 2: Transfer Characteristics

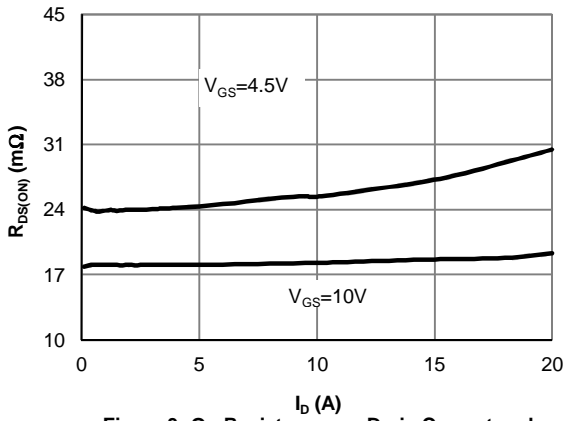

Figure 3: On-Resistance vs. Drain Current and Gate Voltage

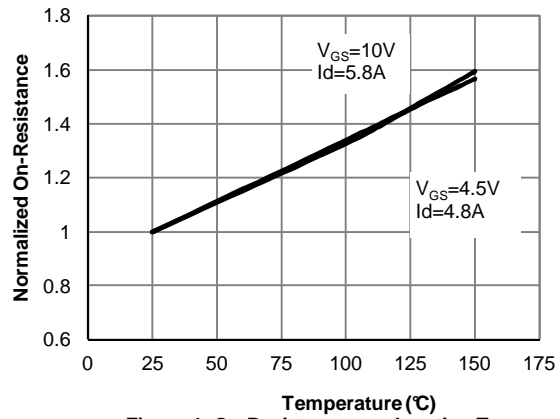

Figure 4: On-Resistance vs. Junction Temperature

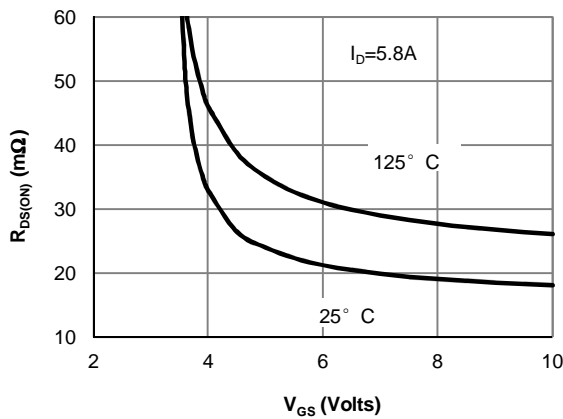

Figure 5: On-Resistance vs. Gate-Source Voltage

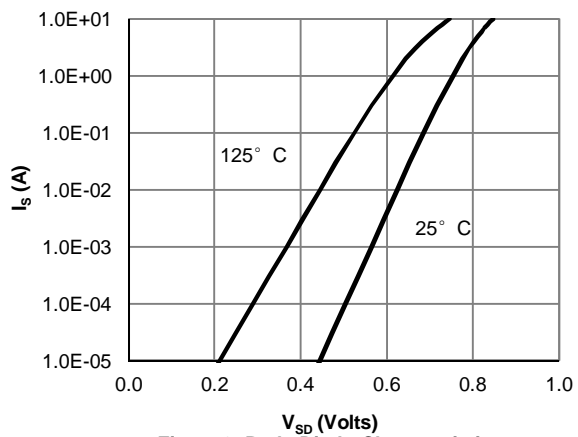

Figure 6: Body-Diode Characteristics



TYPICAL ELECTRICAL AND THERMAL CHARACTERISTICS

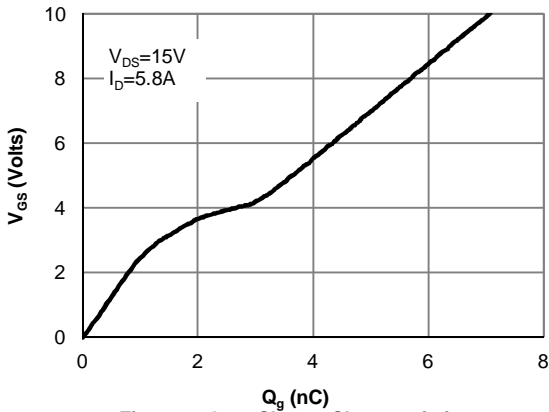

Figure 7: Gate-Charge Characteristics

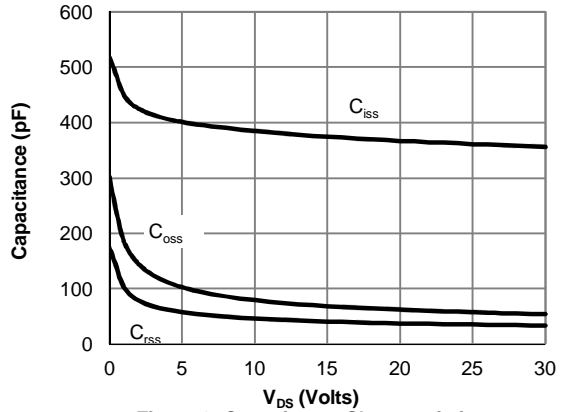

Figure 8: Capacitance Characteristics

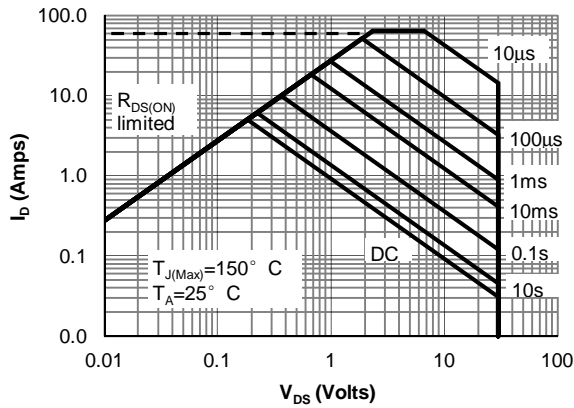

Figure 9: Maximum Forward Biased Safe Operating Area (Note E)

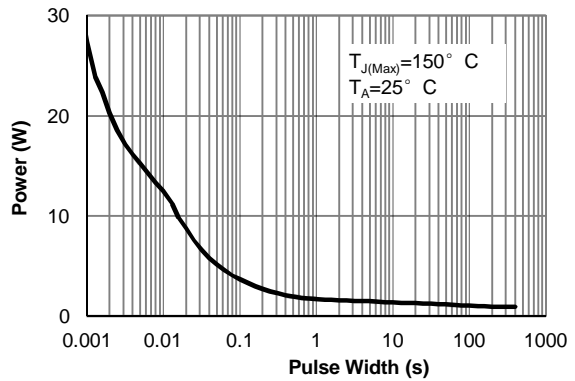

Figure 10: Single Pulse Power Rating Junction-to-Ambient (Note E)

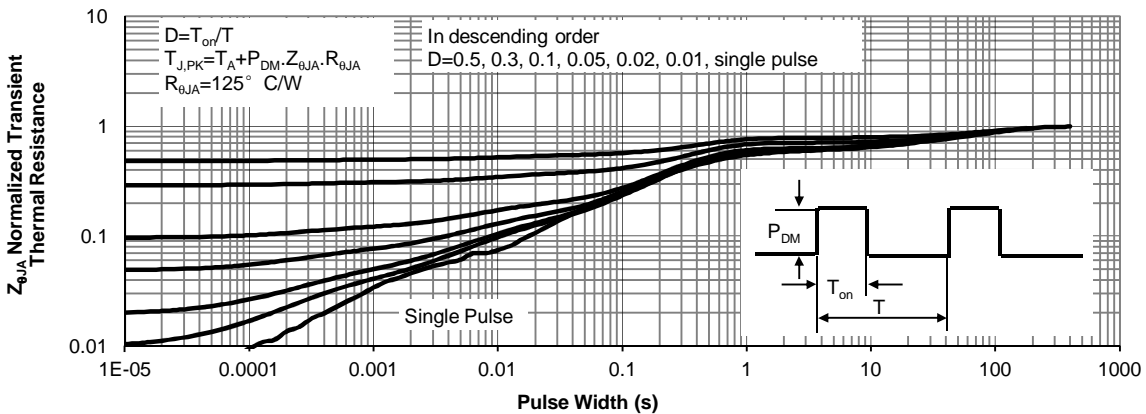
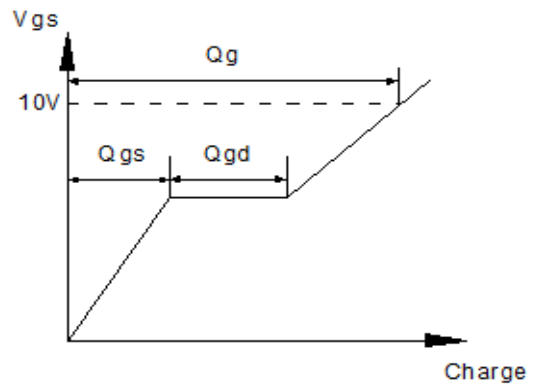
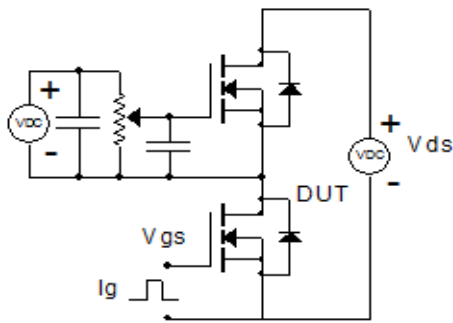

Figure 11: Normalized Maximum Transient Thermal Impedance



Gate Charge Test Circuit & Waveform



Resistive Switching Test Circuit & Waveforms

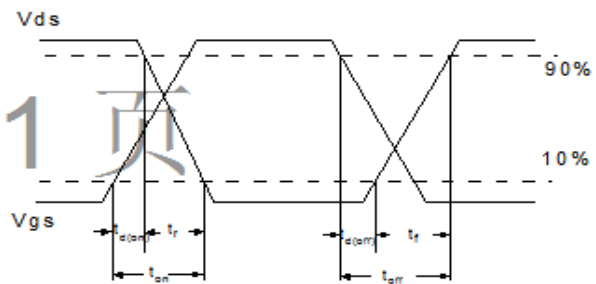
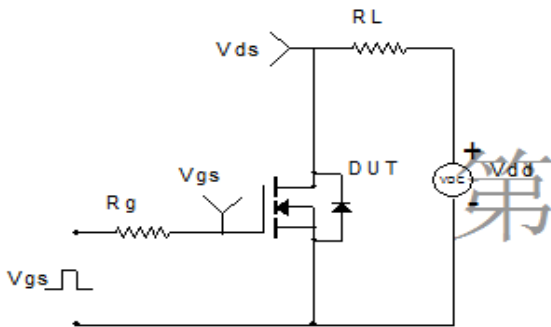

Diode Recovery Test Circuit & Waveforms

