

Typical Application

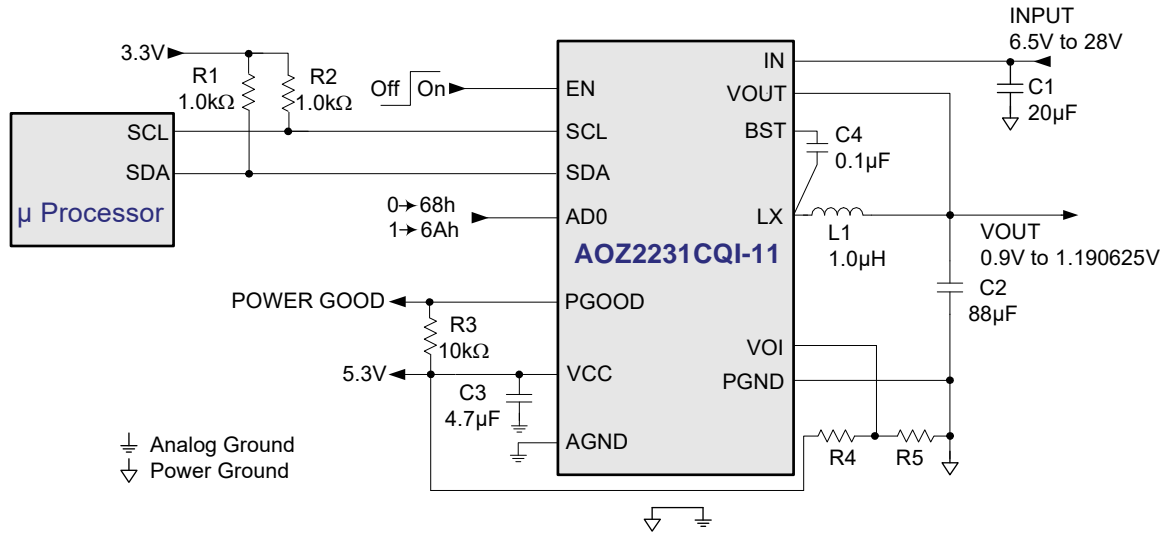

Option Table

Code \ Item	AD0	Address (Binary)	Address (Hex)
AOZ2231CQI-11	Ground (0)	01101000	68h
	Open (1)	01101010	6Ah
AOZ2231CQI-12	Ground (0)	01101100	6Ch
	Open (1)	01101110	6Eh

Recommended Start-up Sequence

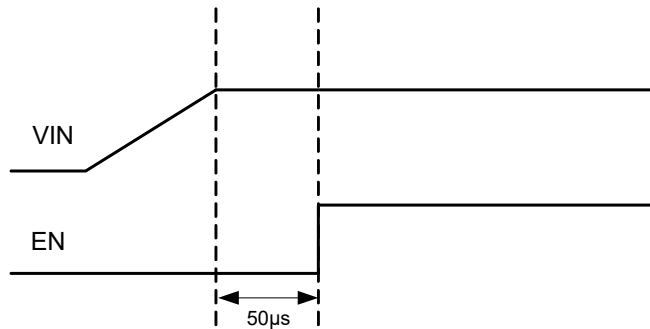

Ordering Information

Part Number	Ambient Temperature Range	Package	Environmental
AOZ2231CQI-11	-40°C to +85°C	22-Pin 4mm x 4mm QFN	Green Product



AOS Green Products use reduced levels of Halogens, and are also RoHS compliant. Please visit www.aosmd.com/media/AOSGreenPolicy.pdf for additional information.

Pin Configuration

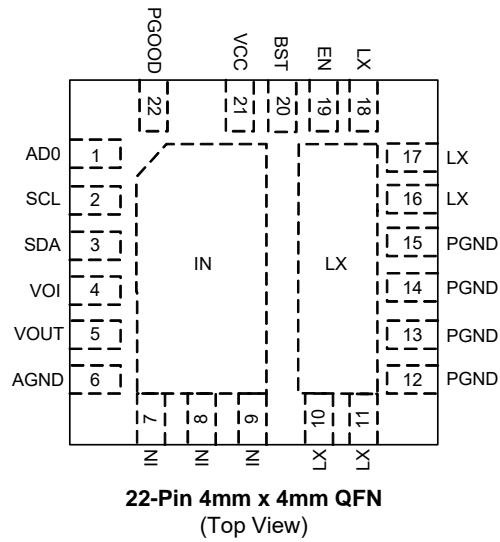

Pin Description

Pin Number	Pin Name	Pin Function
1	AD0	Chip Address. The AD0 pin just connects to AOZ2231CQI-11 VCC pin or GND.
2	SCL	Clock I/O Terminal.
3	SDA	Data I/O Terminal.
4	VOI	Initial Output Voltage Feedback Input. Adjust the output voltage with a resistive voltage-divider between VCC and AGND.
5	VOUT	Output Voltage Feedback Input. Connection to output voltage.
6	AGND	Analog Ground.
7, 8, 9	IN	Supply Input. IN is the regulator input. All IN pins must be connected together.
10, 11, 16, 17, 18	LX	Switching Node.
12, 13, 14, 15	PGND	Power Ground.
19	EN	Enable Input. The AOZ2231CQI-11 is enabled when EN is pulled high. The device shuts down when EN is pulled low.
20	BST	Bootstrap Capacitor Connection. The AOZ2231CQI-11 includes an internal bootstrap diode. Connect an external capacitor between BST and LX as shown in Typical Application diagram.
21	VCC	Supply Input for Analog Functions. Bypass VCC to AGND with a 1 μ F~4.7 μ F ceramic capacitor. Place the capacitor close to VCC pin.
22	PGOOD	Power Good Signal Output. PGOOD is an open-drain output used to indicate the status of the output voltage. It is internally pulled low when the output voltage is 15% lower than the nominal regulation voltage or 20% higher than the nominal regulation voltage. PGOOD is pulled low during soft-start and shut down.

Absolute Maximum Ratings

Exceeding the Absolute Maximum Ratings may damage the device.

Parameter	Rating
IN to AGND	-0.3V to 30V
LX to AGND ⁽¹⁾	-0.3V to 30V
BST to AGND	-0.3V to 36V
PGOOD, EN, VCC, SCL, SDA, VOUT, VOI, AD0 to AGND	-0.3V to 6V
PGND to AGND	-0.3V to +0.3V
Junction Temperature (T _J)	+150°C
Storage Temperature (T _S)	-65°C to +150°C
ESD Rating ⁽²⁾	2kV

Notes:

- LX to PGND Transient (t<20ns) ----- -7V to V_{IN}+7V.
- Devices are inherently ESD sensitive, handling precautions are required. Human body model rating: 1.5kΩ in series with 100pF.

Maximum Operating Ratings

The device is not guaranteed to operate beyond the Maximum Operating ratings.

Parameter	Rating
Supply Voltage (V _{IN})	6.5V to 28V
Output Voltage Range	0.9V to 1.190625V
Ambient Temperature (T _A)	-40°C to +85°C
Package Thermal Resistance (θ _{JA}) (θ _{JC})	32°C/W 4°C/W

Electrical Characteristics

T_A = 25°C, V_{IN}=12V, EN = 5V, unless otherwise specified. Specifications in **BOLD** indicate a temperature range of -40°C to +85°C.

Symbol	Parameter	Conditions	Min.	Typ.	Max	Units
V _{IN}	IN Supply Voltage		6.5		28	V
V _{UVLO}	Under-Voltage Lockout Threshold of V _{CC}	V _{CC} rising V _{CC} falling	3.7	4.2 3.9	4.4	V
I _q	Quiescent Supply Current of V _{CC}	I _{OUT} = 0, V _{EN} ≥ 2V, PFM mode		0.5		mA
I _{OFF}	Shutdown Supply Current	V _{EN} = 0V		1	20	μA
V _{OUT}	Output Voltage	T _A = 25°C, V _{IN} =12V V _{OUT} = 0.9V to 1.190625V, L= 1μH	-2%	0%	2%	V _{OUT}
T _{r_OUT}	Output Voltage Rising Time	V _{OUT} = 0.9V to 1.190625V, C _{OUT} = 88μF, PWM mode	2.5		15	μs
T _{f_OUT}	Output Voltage Falling Time	V _{OUT} = 0.9V to 1.190625V, C _{OUT} = 88μF, PWM mode	2.5		15	μs
Enable						
V _{EN}	EN Input Threshold	Off threshold On threshold	1.4		0.5	V V
V _{EN_HYS}	EN Input Hysteresis			100		mV
AD0						
V _{AD0}	AD0 Input Threshold	Off threshold On threshold	4.2		0.5	V V
Modulator						
f _{SW}	Operating Frequency			400		kHz
T _{ON_MIN}	Minimum On Time			100		ns
T _{ON_MAX}	Maximum On Time			2.6		μs
T _{OFF_MIN}	Minimum Off Time			300		ns
Soft-Start						
T _{SS_OUT}	SS Source Time	for PGOOD pulled High		4		ms

Typical Performance Characteristics

Circuit of Typical Application. $T_A = 25^\circ\text{C}$, $V_{IN} = 19\text{V}$, $V_{OUT} = 1\text{V}$, $f_s = 400\text{kHz}$ unless otherwise specified.

Normal Operation

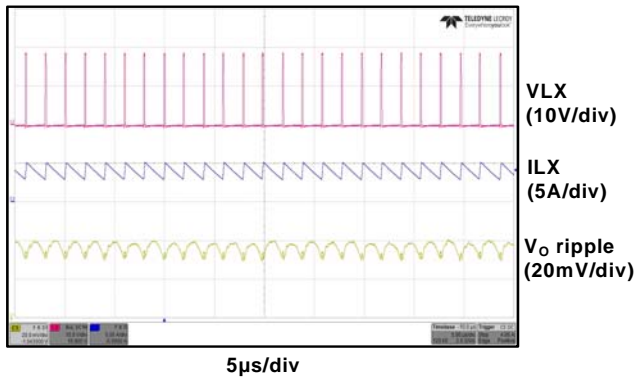

Load Transient 0A to 4A

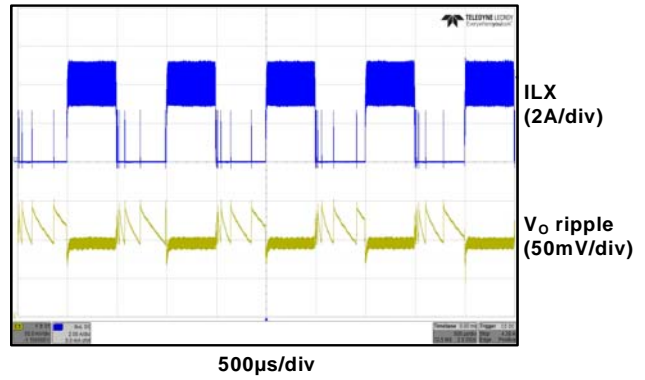

Full Load Start-up

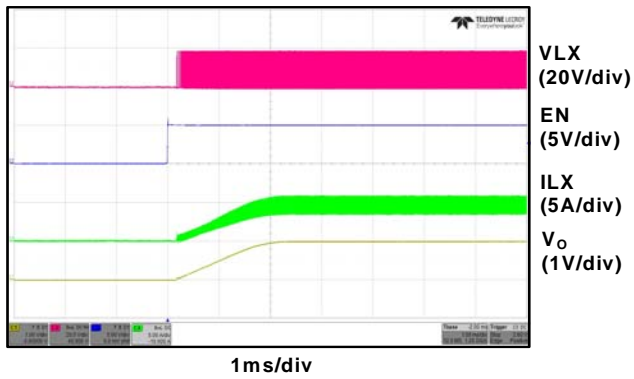

Short Circuit Protection

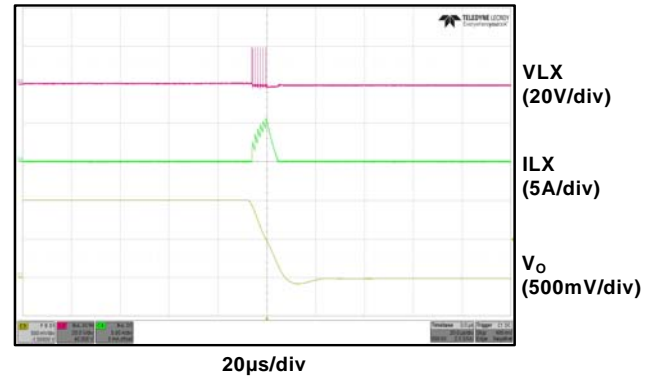

Efficiency vs. Load Current

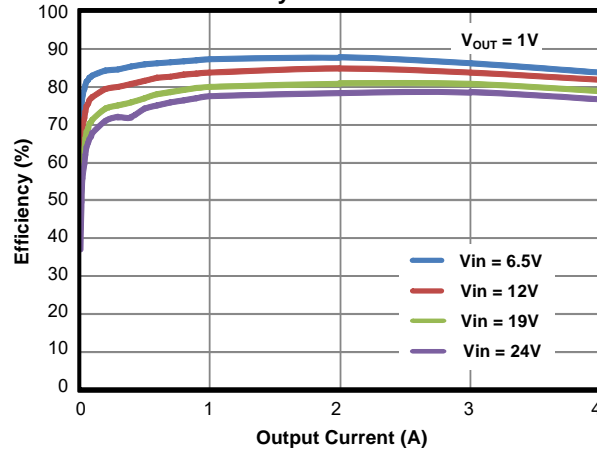

I²C Control Specification⁽³⁾⁽⁴⁾⁽⁵⁾

Symbol	Parameter	Conditions	Min.	Typ.	Max	Units
V _{IL}	Low level input voltage				0.6	V
V _{IH}	High level input voltage		2.9			V
V _{hys}	Hysteresis of Schmitt trigger inputs		0.11			V
V _{OL}	Low level output voltage (Open drain, 3mA sink current)				0.4	V
T _{SP}	Pulse width of spikes suppressed by input filter		32			ns
f _{SCL}	SCL clock frequency				400	kHz
t _{HD;STA}	Hold time (repeated), START condition		0.6			μs
t _{LOW}	Low period of SCL clock		1.3			μs
t _{HIGH}	High period of SCL clock		0.6			μs
t _{SU;STA}	Set-up time for a repeated START condition		0.6			μs
t _{HD;DAT}	Data hold time		50		900	ns
t _{SU;DAT}	Data set-up time		100			ns
t _r	Rise time (SDA or SCL)		20+0.1C _b		300	ns
t _f	Fall time (SDA or SCL)		5+0.1C _b		300	ns
t _{SU;STO}	Set-up time for STOP condition		0.6			μs
t _{BUF}	Bus free time between STOP and START conditions		1.3			μs
C _b	Capacitive load for each bus line				400	pF
I _d	SDA driver capability		25		100	mA

Notes:

- 3. Ensured by design. Not production tested.
- 4. Refer to Figure 1 for I²C timing definitions.
- 5. C_b = capacitance of bus line in pF.

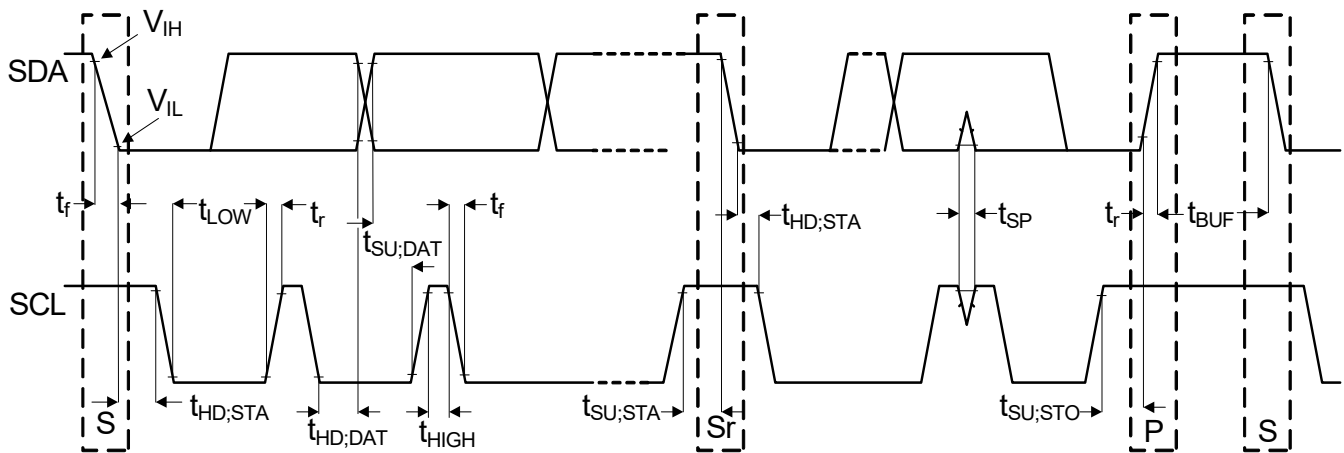

Figure 1. I²C Timing Definitions

I²C Register Maps

Register Name	Register Address	Bit 7	Bit6	Bit 5	Bit 4	Bit 3	Bit 2	Bit 1	Bit 0
Output Voltage	00	Odd Parity	Output Voltage [6:0]						
Control A	01	Internal Mode			Output Voltage Change	PFMb			Protection Mode

Summary of Default Control Bits

Control Bit(s)	Default	Function
VOUT [6:0]	0110010	VOUT code, 7 bits VOUT [6:0]. Part default to 1.068750V.
Internal Mode	0 (External Mode)	0 case: External Mode 1 case: Internal Mode (1). If set to 1, the part switches to internal mode and VOUT register value controls output voltage. (2). The part can be set back to external control mode at any time by wiring this bit to 0.
Output Voltage Change	0	0 case: Internal protection on 1 case: Internal protection off (1). If set to 0, when VOUT code change, the internal protection isn't turned off. (2). If set to 1, when VOUT code change, the internal protection is turned off to avoid triggering internal protection.
PFMb	1	Select PFM or PWM at light load. 0 case: PFM 1 case: PWM Part defaults to PWM.
Protection Mode	1	Select Latch-off or Auto-recovery for protection. 0 case: Auto-recovery mode 1 case: Latch-off mode Part defaults to Latch-off mode.

Odd Parity Bit

The odd parity bit is set by the Master controller to be the exclusive-NOR of the output voltage [6:0] bits. It will be used by the AOZ2231CQI-11 to check that a valid data byte has been received. If odd parity is not equal to the exclusive-NOR of the output voltage [6:0] bits, the

AOZ2231CQI-11 assumes that an error has been occurred during the data transmission, and it will not send an ACK bit, nor will it reset the VOUT to the received code. (or, if the Control register will not reset the register contents as requested). The Master should try again to re-send the data. When reading back the VOUT register, the parity bit is sent back.

