

### General Description

The AO4407A uses advanced trench technology to provide excellent  $R_{DS(ON)}$ , and ultra-low low gate charge with a 25V gate rating. This device is suitable for use as a load switch or in PWM applications.

\* RoHS and Halogen-Free Compliant

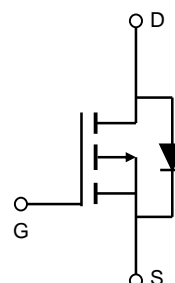
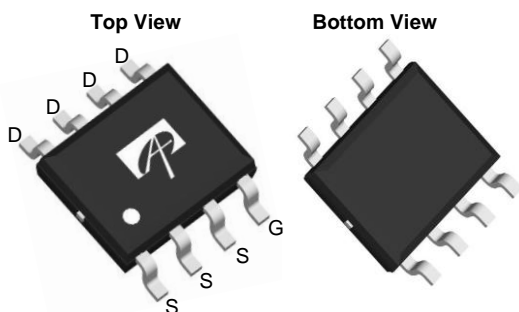
### Product Summary

$V_{DS} = -30V$   
 $I_D = -12A$  ( $V_{GS} = -20V$ )  
 $R_{DS(ON)} < 11m\Omega$  ( $V_{GS} = -20V$ )  
 $R_{DS(ON)} < 13m\Omega$  ( $V_{GS} = -10V$ )  
 $R_{DS(ON)} < 17m\Omega$  ( $V_{GS} = -6V$ )

100% UIS Tested  
 100% Rg Tested



SOIC-8



### Absolute Maximum Ratings $T_A=25^\circ C$ unless otherwise noted

Parameter	Symbol	Maximum	Units
Drain-Source Voltage	$V_{DS}$	-30	V
Gate-Source Voltage	$V_{GS}$	$\pm 25$	V
Continuous Drain Current <sup>A</sup>	$I_D$	$T_A=25^\circ C$	-12
		$T_A=70^\circ C$	-10
Pulsed Drain Current <sup>B</sup>	$I_{DM}$	-60	A
Avalanche Current <sup>G</sup>	$I_{AR}$	-26	
Repetitive avalanche energy $L=0.3mH$ <sup>G</sup>	$E_{AR}$	101	mJ
Power Dissipation <sup>A</sup>	$P_D$	$T_A=25^\circ C$	3.1
		$T_A=70^\circ C$	2.0
Junction and Storage Temperature Range	$T_J, T_{STG}$	-55 to 150	$^\circ C$

### Thermal Characteristics

Parameter	Symbol	Typ	Max	Units
Maximum Junction-to-Ambient <sup>A</sup>	$R_{\theta JA}$	32	40	$^\circ C/W$
$t \leq 10s$				
Maximum Junction-to-Ambient <sup>A</sup>	$R_{\theta JL}$	17	24	$^\circ C/W$
Steady State				
Maximum Junction-to-Lead <sup>C</sup>				

**Electrical Characteristics (T<sub>J</sub>=25°C unless otherwise noted)**

Symbol	Parameter	Conditions	Min	Typ	Max	Units
<b>STATIC PARAMETERS</b>						
BV <sub>DSS</sub>	Drain-Source Breakdown Voltage	I <sub>D</sub> = -250μA, V <sub>GS</sub> = 0V	-30			V
I <sub>DSS</sub>	Zero Gate Voltage Drain Current	V <sub>DS</sub> = -30V, V <sub>GS</sub> = 0V T <sub>J</sub> = 55°C			-1 -5	μA
I <sub>GSS</sub>	Gate-Body leakage current	V <sub>DS</sub> = 0V, V <sub>GS</sub> = ±25V			±100	nA
V <sub>GS(th)</sub>	Gate Threshold Voltage	V <sub>DS</sub> = V <sub>GS</sub> , I <sub>D</sub> = -250μA	-1.7	-2.3	-3	V
I <sub>D(ON)</sub>	On state drain current	V <sub>GS</sub> = -10V, V <sub>DS</sub> = -5V	-60			A
R <sub>DS(ON)</sub>	Static Drain-Source On-Resistance	V <sub>GS</sub> = -20V, I <sub>D</sub> = -12A T <sub>J</sub> = 125°C		8.5	11	mΩ
		V <sub>GS</sub> = -10V, I <sub>D</sub> = -12A		10	13	
		V <sub>GS</sub> = -6V, I <sub>D</sub> = -10A		12.7	17	
g <sub>FS</sub>	Forward Transconductance	V <sub>DS</sub> = -5V, I <sub>D</sub> = -10A		21		S
V <sub>SD</sub>	Diode Forward Voltage	I <sub>S</sub> = -1A, V <sub>GS</sub> = 0V		-0.7	-1	V
I <sub>S</sub>	Maximum Body-Diode Continuous Current				-3	A
<b>DYNAMIC PARAMETERS</b>						
C <sub>iss</sub>	Input Capacitance	V <sub>GS</sub> =0V, V <sub>DS</sub> =-15V, f=1MHz		2060	2600	pF
C <sub>oss</sub>	Output Capacitance			370		pF
C <sub>rss</sub>	Reverse Transfer Capacitance			295		pF
R <sub>g</sub>	Gate resistance	V <sub>GS</sub> =0V, V <sub>DS</sub> =0V, f=1MHz		2.4	3.6	Ω
<b>SWITCHING PARAMETERS</b>						
Q <sub>g</sub>	Total Gate Charge	V <sub>GS</sub> =-10V, V <sub>DS</sub> =-15V, I <sub>D</sub> =-12A		30	39	nC
Q <sub>gs</sub>	Gate Source Charge			4.6		nC
Q <sub>gd</sub>	Gate Drain Charge			10		nC
t <sub>D(on)</sub>	Turn-On DelayTime	V <sub>GS</sub> =-10V, V <sub>DS</sub> =-15V, R <sub>L</sub> =1.25Ω, R <sub>GEN</sub> =3Ω		11		ns
t <sub>r</sub>	Turn-On Rise Time			9.4		ns
t <sub>D(off)</sub>	Turn-Off DelayTime			24		ns
t <sub>f</sub>	Turn-Off Fall Time			12		ns
t <sub>rr</sub>	Body Diode Reverse Recovery Time	I <sub>F</sub> =-12A, di/dt=100A/μs		30	40	ns
Q <sub>rr</sub>	Body Diode Reverse Recovery Charge	I <sub>F</sub> =-12A, di/dt=100A/μs		22		nC

A: The value of R<sub>θJA</sub> is measured with the device mounted on 1 in<sup>2</sup> FR-4 board with 2oz. Copper, in a still air environment with T<sub>A</sub> = 25° C. The value in any given application depends on the user's specific board design. The current rating is based on the t ≤ 10s thermal resistance rating.

B: Repetitive rating, pulse width limited by junction temperature.

C: The R<sub>θJA</sub> is the sum of the thermal impedance from junction to lead R<sub>θJL</sub> and lead to ambient.

D: The static characteristics in Figures 1 to 6 are obtained using < 300μs pulses, duty cycle 0.5% max.

E: These tests are performed with the device mounted on 1 in<sup>2</sup> FR-4 board with 2oz. Copper, in a still air environment with T<sub>A</sub>=25° C. The SOA curve provides a single pulse rating.

F: The current rating is based on the t ≤ 10s thermal resistance rating.

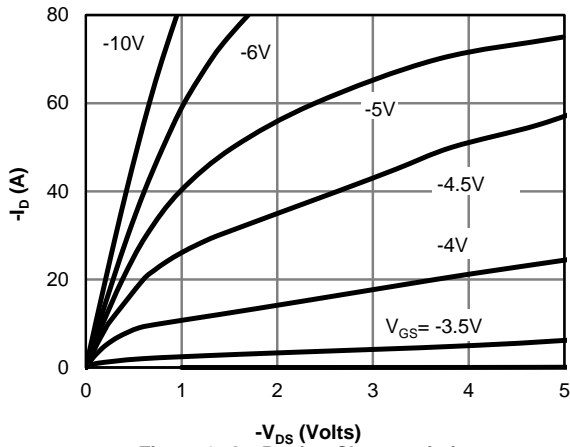
G: E<sub>AR</sub> and I<sub>AR</sub> ratings are based on low frequency and duty cycles to keep T<sub>J</sub>=25C.

APPLICATIONS OR USES AS CRITICAL COMPONENTS IN LIFE SUPPORT DEVICES OR SYSTEMS ARE NOT AUTHORIZED. AOS DOES NOT ASSUME ANY LIABILITY ARISING OUT OF SUCH APPLICATIONS OR USES OF ITS PRODUCTS. AOS RESERVES THE RIGHT TO MAKE CHANGES TO PRODUCT SPECIFICATIONS WITHOUT NOTICE. IT IS THE RESPONSIBILITY OF THE CUSTOMER TO EVALUATE SUITABILITY OF THE PRODUCT FOR THEIR INTENDED APPLICATION. CUSTOMER SHALL COMPLY WITH APPLICABLE LEGAL REQUIREMENTS, INCLUDING ALL APPLICABLE EXPORT CONTROL RULES, REGULATIONS AND LIMITATIONS.

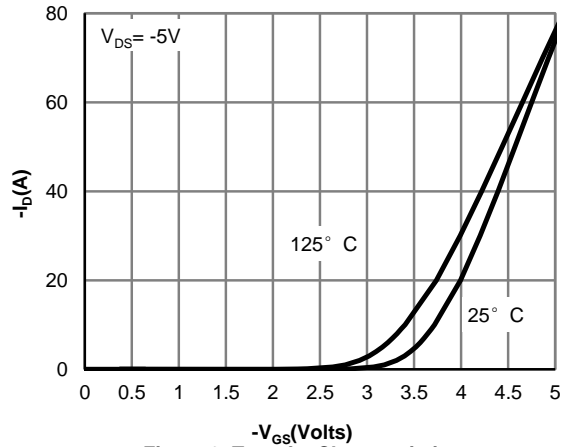
AOS' products are provided subject to AOS' terms and conditions of sale which are set forth at:

[http://www.aosmd.com/terms\\_and\\_conditions\\_of\\_sale](http://www.aosmd.com/terms_and_conditions_of_sale)

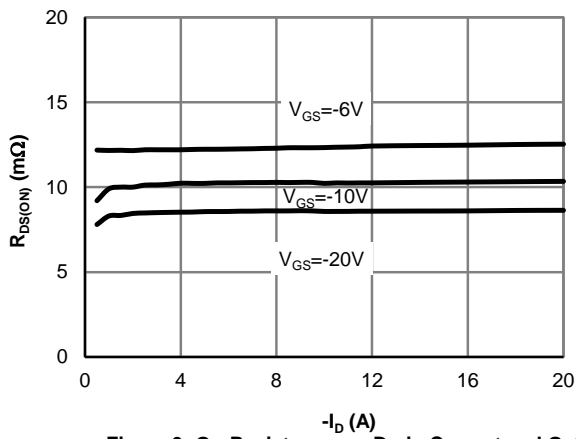
**TYPICAL ELECTRICAL AND THERMAL CHARACTERISTICS**



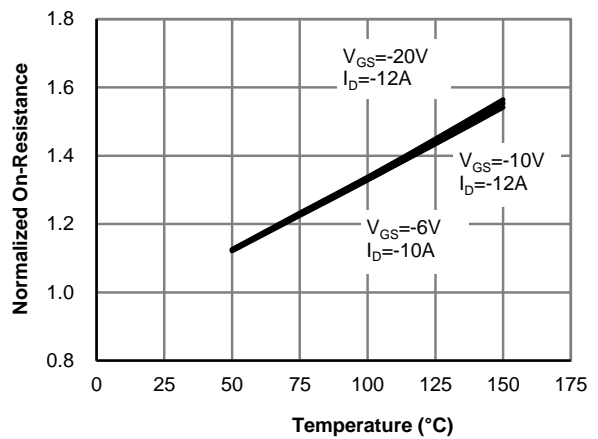
**Figure 1: On-Region Characteristics**



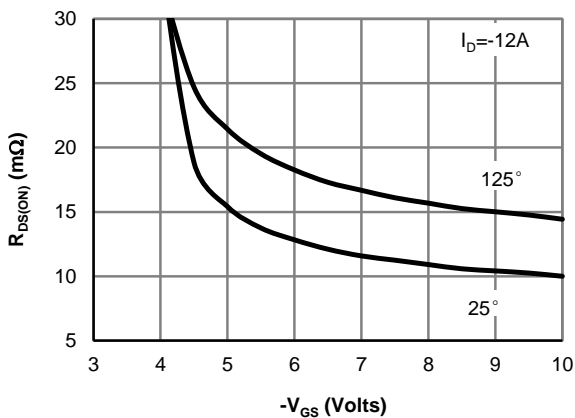
**Figure 2: Transfer Characteristics**



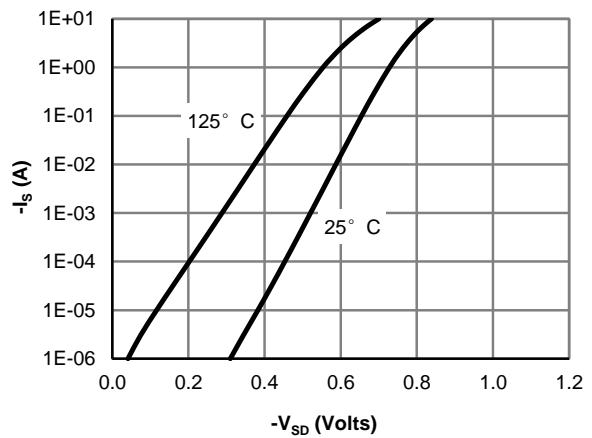
**Figure 3: On-Resistance vs. Drain Current and Gate Voltage**



**Figure 4: On-Resistance vs. Junction Temperature**

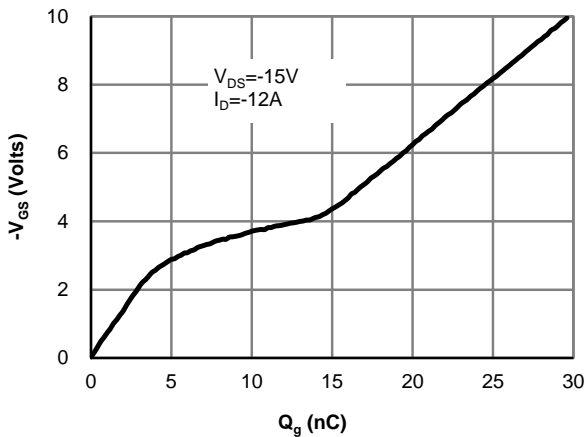


**Figure 5: On-Resistance vs. Gate-Source Voltage**

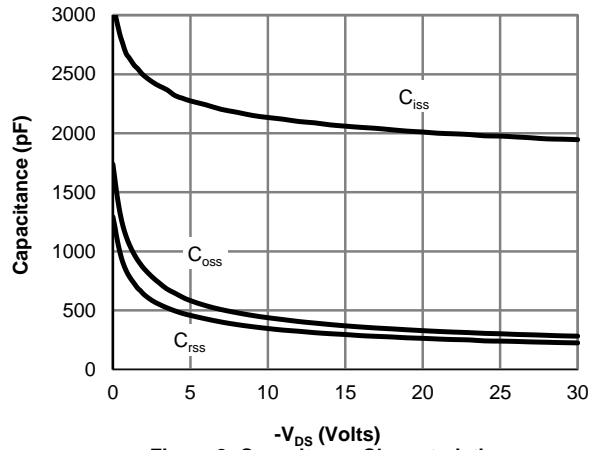


**Figure 6: Body-Diode Characteristics**

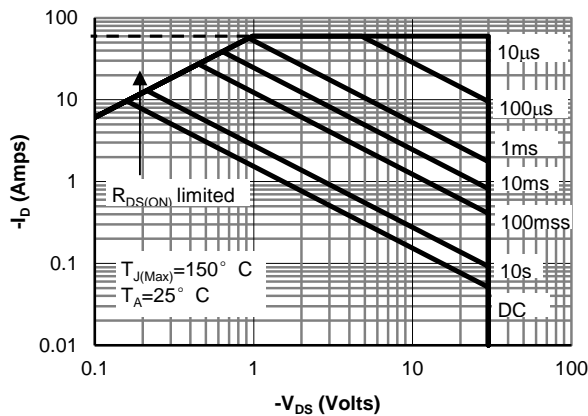
**TYPICAL ELECTRICAL AND THERMAL CHARACTERISTICS**



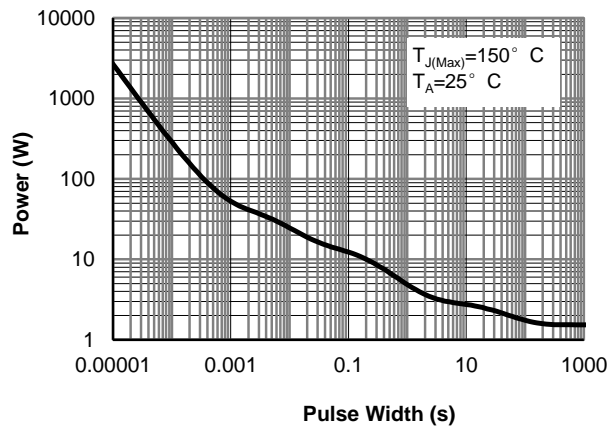
**Figure 7: Gate-Charge Characteristics**



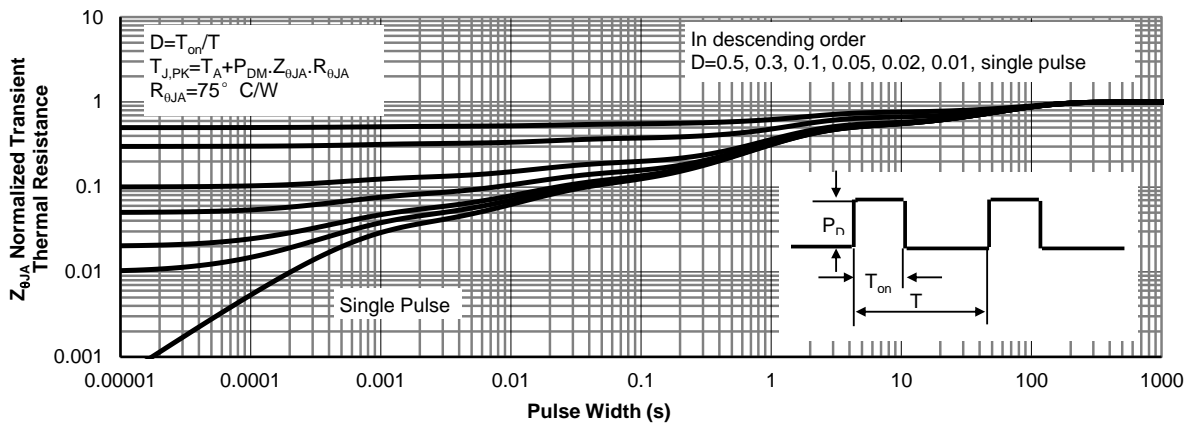
**Figure 8: Capacitance Characteristics**



**Figure 9: Maximum Forward Biased Safe Operating Area (Note E)**

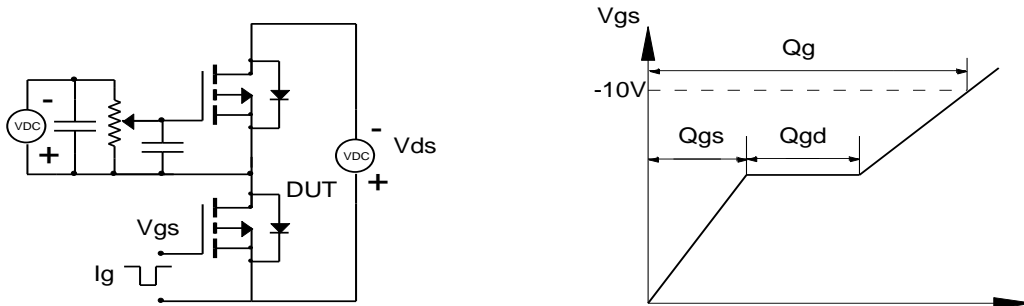


**Figure 10: Single Pulse Power Rating Junction-to-Ambient (Note E)**

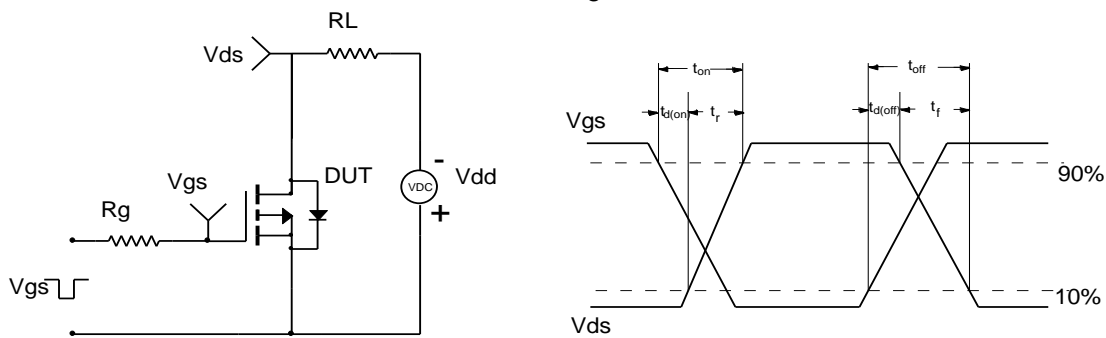


**Figure 11: Normalized Maximum Transient Thermal Impedance (Note E)**

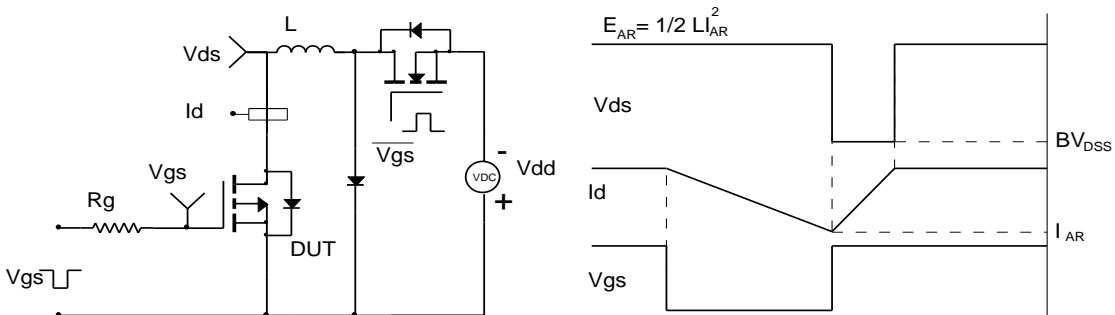
**Gate Charge Test Circuit & Waveform**



**Resistive Switching Test Circuit & Waveforms**



**Unclamped Inductive Switching (UIS) Test Circuit & Waveforms**



**Diode Recovery Test Circuit & Waveforms**

