

General Description

- Latest Alpha IGBT (α IGBT) technology
- High efficient turn-on di/dt controllability
- Very high switching speed
- Low turn-off switching loss and softness
- Very good EMI behavior
- Short-circuit ruggedness

Applications

- Welding Machines
- Motor Drives
- UPS & Solar Inverters
- Very High Switching Frequency Applications

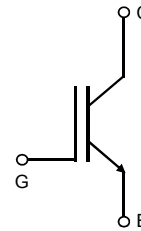
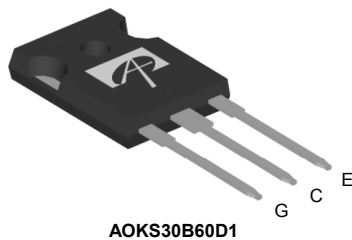
Product Summary

V_{CE}	600V
I_C ($T_C=100^\circ\text{C}$)	30A
$V_{CE(sat)}$ ($T_C=25^\circ\text{C}$)	2.0V



Top View

TO-247



Absolute Maximum Ratings $T_A=25^\circ\text{C}$ unless otherwise noted

Parameter	Symbol	AOKS30B60D1	Units	
Collector-Emitter Voltage	V_{CE}	600	V	
Gate-Emitter Voltage	V_{GE}	± 20	V	
V_{GE} Spike	500ns	V_{SPIKE}	24	V
Continuous Collector Current	I_C	$T_C=25^\circ\text{C}$	60	A
		$T_C=100^\circ\text{C}$	30	
Pulsed Collector Current, Limited by T_{Jmax}	I_{CM}	96	A	
Turn off SOA, $V_{CE} \leq 600\text{V}$, Limited by T_{Jmax}	I_{LM}	96	A	
Short circuit withstanding time $V_{GE} = 15\text{V}$, $V_{CE} \leq 400\text{V}$, Delay between short circuits $\geq 1.0\text{s}$, $T_C=25^\circ\text{C}$	t_{SC}	10	μs	
Power Dissipation	P_D	$T_C=25^\circ\text{C}$	208	W
		$T_C=100^\circ\text{C}$	83	
Junction and Storage Temperature Range	T_J, T_{STG}	-55 to 150	$^\circ\text{C}$	
Maximum lead temperature for soldering purpose, 1/8" from case for 5 seconds	T_L	300	$^\circ\text{C}$	

Thermal Characteristics

Parameter	Symbol	AOKS30B60D1	Units
Maximum Junction-to-Ambient	$R_{\theta JA}$	40	$^\circ\text{C/W}$
Maximum IGBT Junction-to-Case	$R_{\theta JC}$	0.6	$^\circ\text{C/W}$

Electrical Characteristics (T_J=25°C unless otherwise noted)

Symbol	Parameter	Conditions	Min	Typ	Max	Units	
STATIC PARAMETERS							
BV_{CES}	Collector-Emitter Breakdown Voltage	$I_C=1mA, V_{GE}=0V, T_J=25^\circ C$	600	-	-	V	
$V_{CE(sat)}$	Collector-Emitter Saturation Voltage	$V_{GE}=15V, I_C=30A$	$T_J=25^\circ C$	-	2.0	2.5	V
			$T_J=125^\circ C$	-	2.4	-	
			$T_J=150^\circ C$	-	2.5	-	
$V_{GE(th)}$	Gate-Emitter Threshold Voltage	$V_{CE}=5V, I_C=1mA$	-	5.6	-	V	
I_{CES}	Zero Gate Voltage Collector Current	$V_{CE}=600V, V_{GE}=0V$	$T_J=25^\circ C$	-	-	10	μA
			$T_J=125^\circ C$	-	-	400	
			$T_J=150^\circ C$	-	-	2000	
I_{GES}	Gate-Emitter leakage current	$V_{CE}=0V, V_{GE}=\pm 20V$	-	-	± 100	nA	
g_{FS}	Forward Transconductance	$V_{CE}=20V, I_C=30A$	-	13	-	S	
DYNAMIC PARAMETERS							
C_{ies}	Input Capacitance	$V_{GE}=0V, V_{CE}=25V, f=1MHz$	-	1324	-	pF	
C_{oes}	Output Capacitance		-	120	-	pF	
C_{res}	Reverse Transfer Capacitance		-	5	-	pF	
Q_g	Total Gate Charge	$V_{GE}=15V, V_{CE}=480V, I_C=30A$	-	34	-	nC	
Q_{ge}	Gate to Emitter Charge		-	14.3	-	nC	
Q_{gc}	Gate to Collector Charge		-	10.7	-	nC	
$I_{C(SC)}$	Short circuit collector current, Max. 1000 short circuits, Delay between short circuits $\geq 1.0s$	$V_{GE}=15V, V_{CE}=400V, R_G=25\Omega$	-	96	-	A	
R_g	Gate resistance	$f=1MHz$	-	1.3	-	Ω	
SWITCHING PARAMETERS, (Load Inductive, T_J=25°C)							
$t_{D(on)}$	Turn-On DelayTime	$T_J=25^\circ C$ $V_{GE}=15V, V_{CE}=400V, I_C=30A,$ $R_G=10\Omega,$ Parasitic Inductance=150nH Eon and Etotal include diode (AOK30B60D1) reverse recovery	-	20	-	ns	
t_r	Turn-On Rise Time		-	44	-	ns	
$t_{D(off)}$	Turn-Off Delay Time		-	58	-	ns	
t_f	Turn-Off Fall Time		-	16	-	ns	
E_{on}	Turn-On Energy		-	1.1	-	mJ	
E_{off}	Turn-Off Energy		-	0.24	-	mJ	
E_{total}	Total Switching Energy		-	1.34	-	mJ	
SWITCHING PARAMETERS, (Load Inductive, T_J=150°C)							
$t_{D(on)}$	Turn-On DelayTime	$T_J=150^\circ C$ $V_{GE}=15V, V_{CE}=400V, I_C=30A,$ $R_G=10\Omega,$ Parasitic Inductance=150nH Eon and Etotal include diode (AOK30B60D1) reverse recovery	-	21	-	ns	
t_r	Turn-On Rise Time		-	45	-	ns	
$t_{D(off)}$	Turn-Off Delay Time		-	70	-	ns	
t_f	Turn-Off Fall Time		-	19	-	ns	
E_{on}	Turn-On Energy		-	1.3	-	mJ	
E_{off}	Turn-Off Energy		-	0.46	-	mJ	
E_{total}	Total Switching Energy		-	1.76	-	mJ	

THIS PRODUCT HAS BEEN DESIGNED AND QUALIFIED FOR THE CONSUMER MARKET. APPLICATIONS OR USES AS CRITICAL COMPONENTS IN LIFE SUPPORT DEVICES OR SYSTEMS ARE NOT AUTHORIZED. AOS DOES NOT ASSUME ANY LIABILITY ARISING OUT OF SUCH APPLICATIONS OR USES OF ITS PRODUCTS. AOS RESERVES THE RIGHT TO IMPROVE PRODUCT DESIGN, FUNCTIONS AND RELIABILITY WITHOUT NOTICE.

TYPICAL ELECTRICAL AND THERMAL CHARACTERISTICS

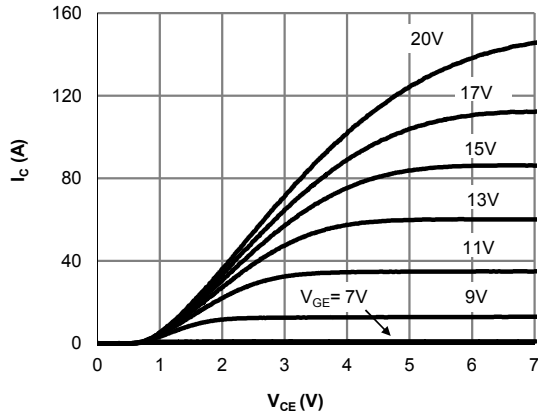


Figure 1: Output Characteristic
($T_j=25^\circ\text{C}$)

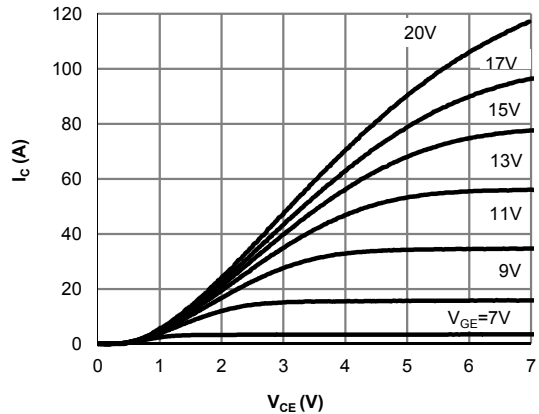


Figure 2: Output Characteristic
($T_j=150^\circ\text{C}$)

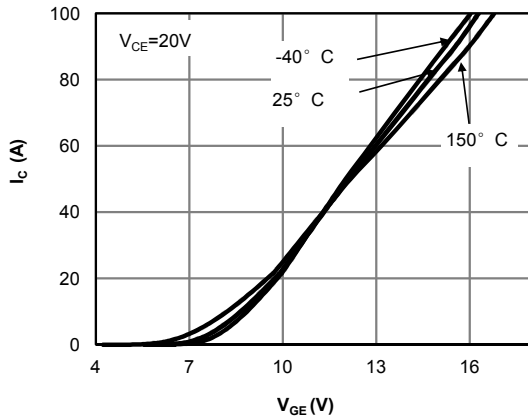


Figure 3: Transfer Characteristic

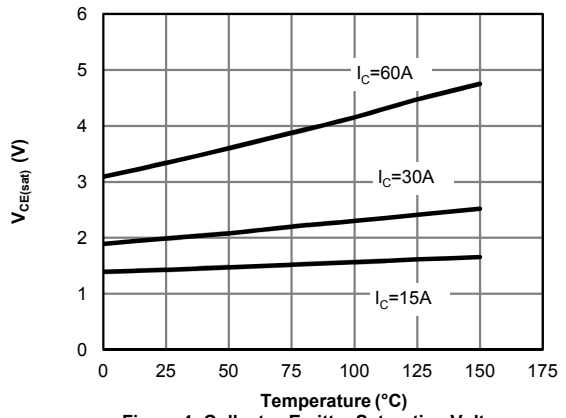


Figure 4: Collector-Emitter Saturation Voltage vs. Junction Temperature

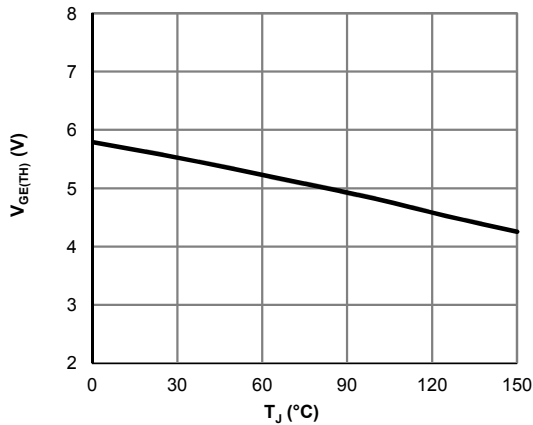


Figure 5: $V_{GE(TH)}$ vs. T_j

TYPICAL ELECTRICAL AND THERMAL CHARACTERISTICS

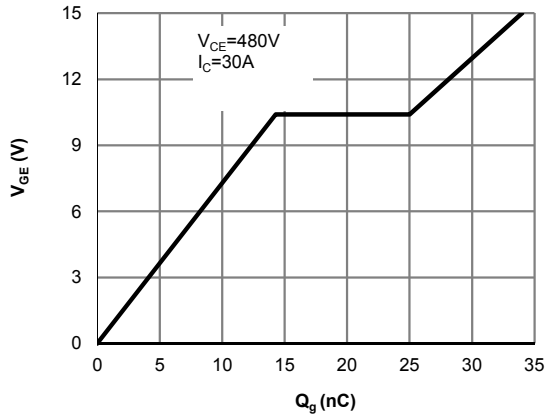


Figure 6: Gate-Charge Characteristics

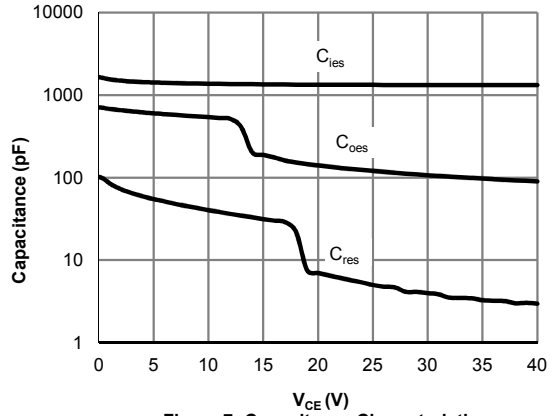


Figure 7: Capacitance Characteristic

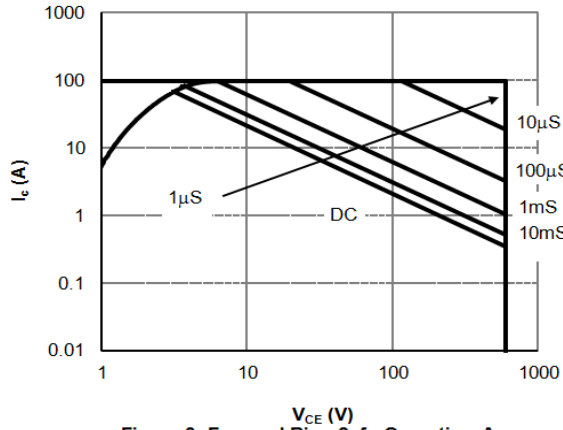


Figure 8: Forward Bias Safe Operating Area
($T_C=25^\circ\text{C}$, $V_{GE}=15\text{V}$)

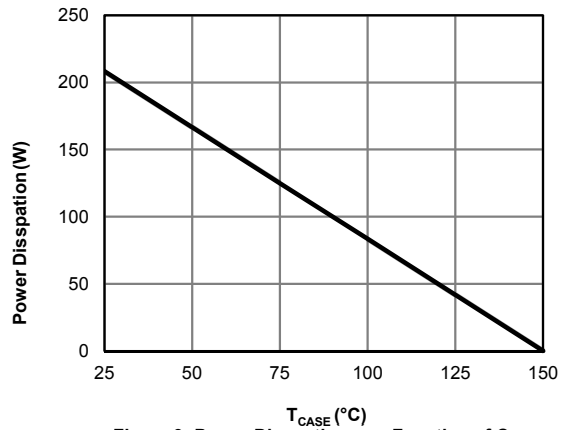


Figure 9: Power Dissipation as a Function of Case

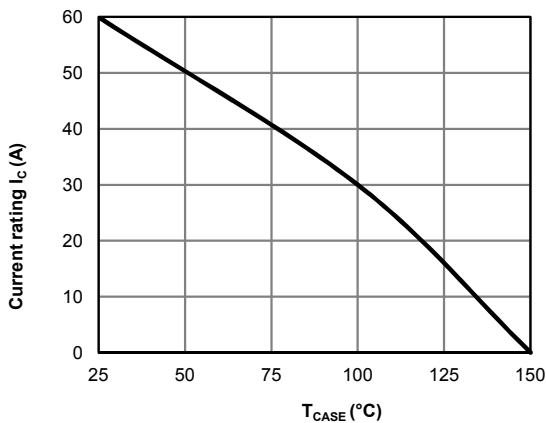


Figure 10: Current De-rating

TYPICAL ELECTRICAL AND THERMAL CHARACTERISTICS

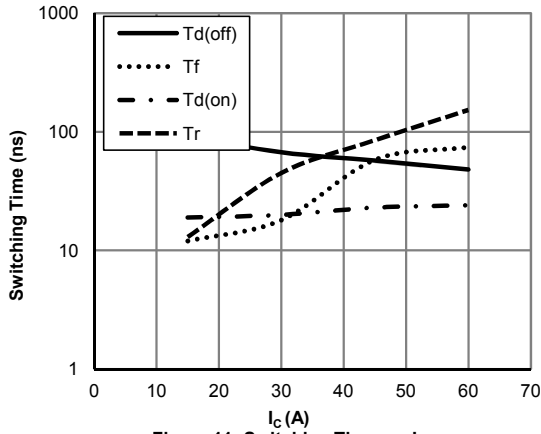


Figure 11: Switching Time vs. I_c
($T_j=150^\circ\text{C}$, $V_{GE}=15\text{V}$, $V_{CE}=400\text{V}$, $R_g=10\Omega$)

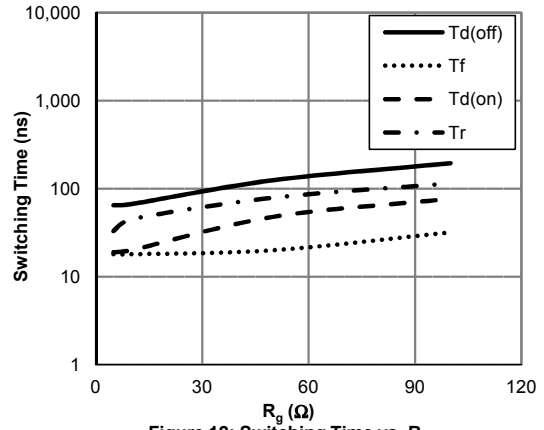


Figure 12: Switching Time vs. R_g
($T_j=150^\circ\text{C}$, $V_{GE}=15\text{V}$, $V_{CE}=400\text{V}$, $I_c=30\text{A}$)

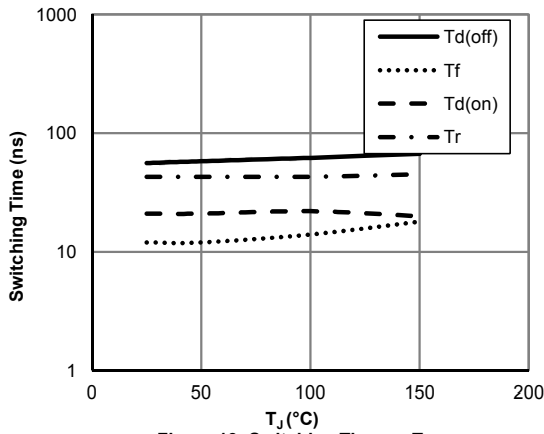


Figure 13: Switching Time vs. T_j
($V_{GE}=15\text{V}$, $V_{CE}=400\text{V}$, $I_c=30\text{A}$, $R_g=10\Omega$)

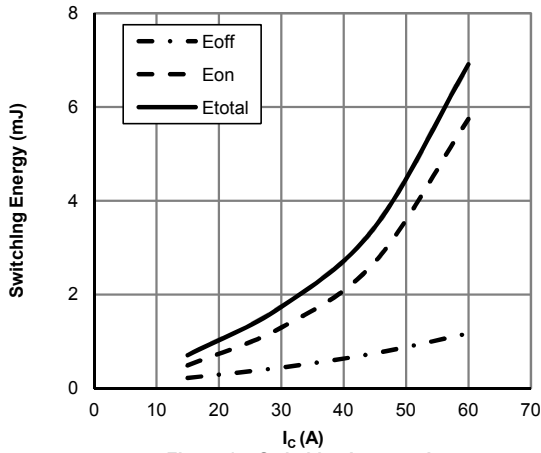
TYPICAL ELECTRICAL AND THERMAL CHARACTERISTICS


Figure 14: Switching Loss vs. I_C
 ($T_J=150^\circ\text{C}$, $V_{GE}=15\text{V}$, $V_{CE}=400\text{V}$, $R_g=10\Omega$)

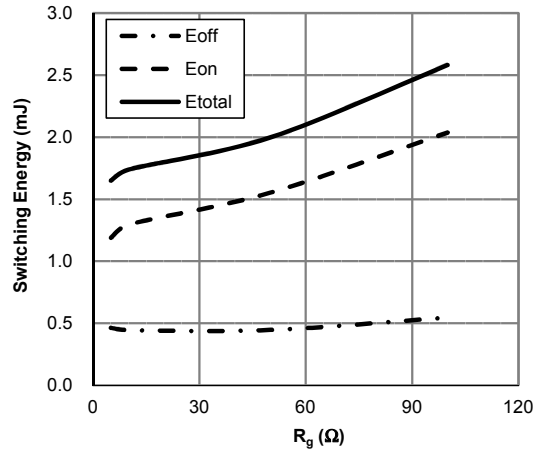


Figure 15: Switching Loss vs. R_g
 ($T_J=150^\circ\text{C}$, $V_{GE}=15\text{V}$, $V_{CE}=400\text{V}$, $I_C=30\text{A}$)

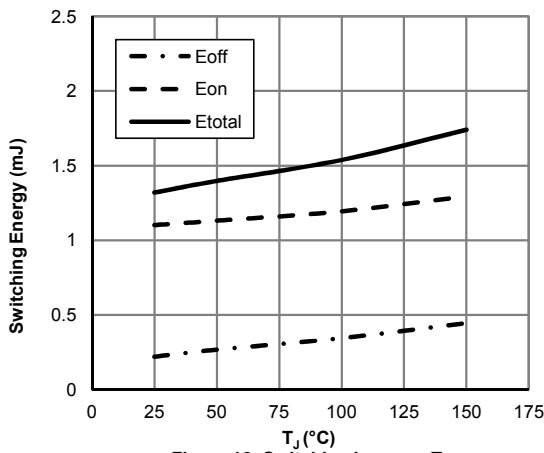


Figure 16: Switching Loss vs. T_J
 ($V_{GE}=15\text{V}$, $V_{CE}=400\text{V}$, $I_C=30\text{A}$, $R_g=10\Omega$)

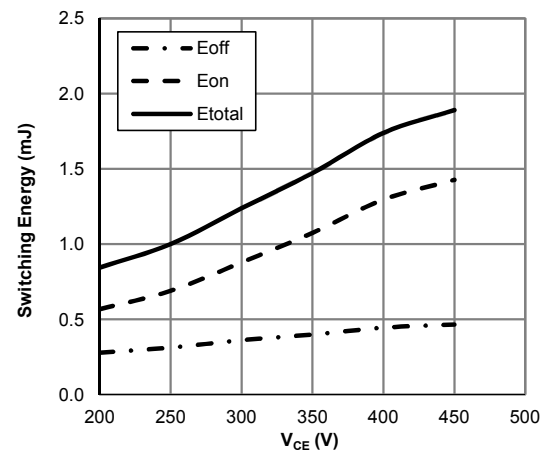


Figure 17: Switching Loss vs. V_{CE}
 ($T_J=150^\circ\text{C}$, $V_{GE}=15\text{V}$, $I_C=30\text{A}$, $R_g=10\Omega$)

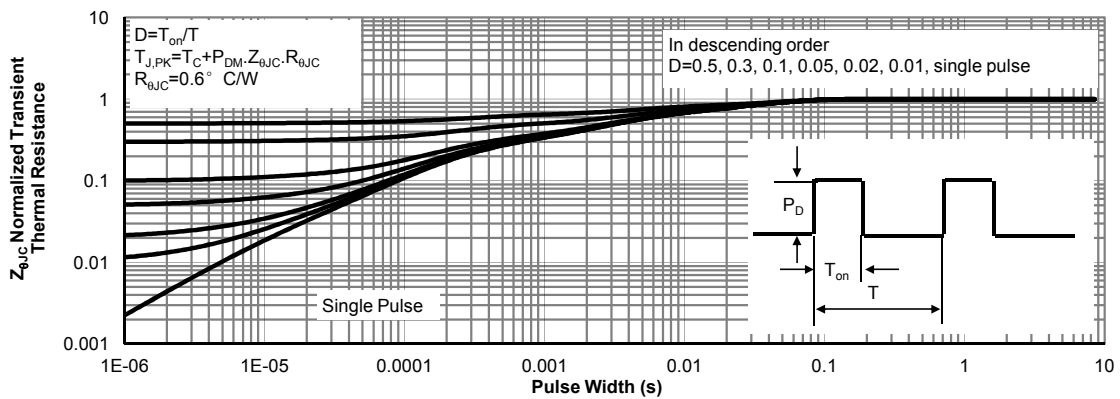


Figure 18: Normalized Maximum Transient Thermal Impedance for IGBT

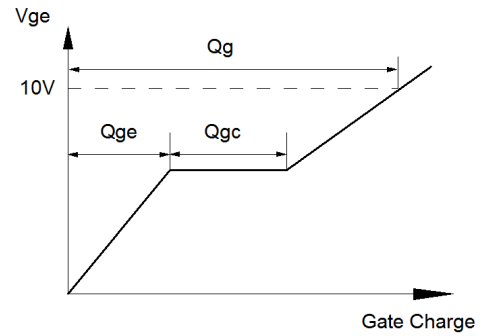
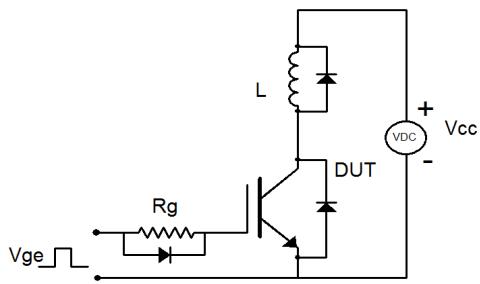


Figure A: Gate Charge Test Circuit & Waveforms

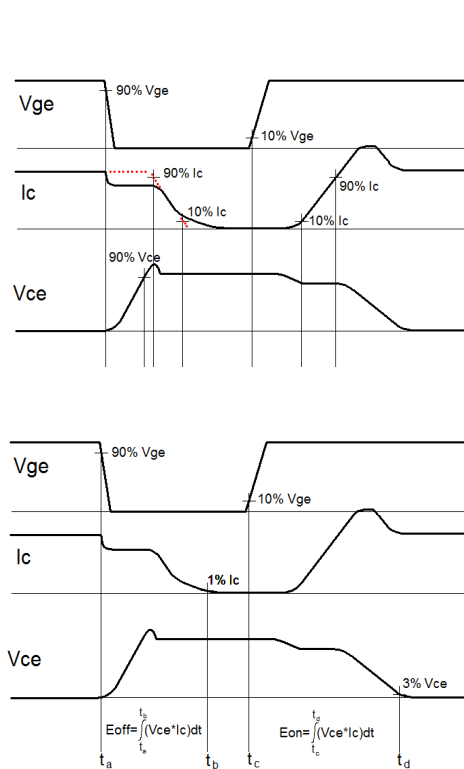
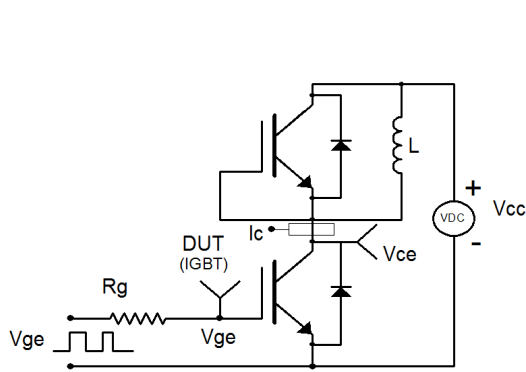


Figure B: Inductive Switching Test Circuit & Waveforms