

### General Description

- Latest AlphaIGBT (αIGBT) Technology
- 650V Breakdown Voltage
- High Efficient Turn-On di/dt Controllability
- Very High Switching Speed
- Low Turn-Off Switching Loss and Softness
- Very Good EMI Behavior

### Applications

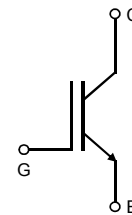
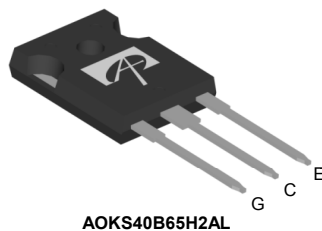
- PFC Circuits
- Very High Switching Frequency Applications

### Product Summary

$V_{CE}$	650V
$I_C$ ( $T_C=100^\circ\text{C}$ )	40A
$V_{CE(sat)}$ ( $T_J=25^\circ\text{C}$ )	2.05V



TO-247



Orderable Part Number	Package Type	Form	Minimum Order Quantity
AOKS40B65H2AL	TO247	Tube	240
<b>Absolute Maximum Ratings <math>T_A=25^\circ\text{C}</math> unless otherwise noted</b>			
Parameter	Symbol	AOKS40B65H2AL	Units
Collector-Emitter Voltage	$V_{CE}$	650	V
Gate-Emitter Voltage	$V_{GE}$	$\pm 30$	V
Continuous Collector Current	$I_C$	$T_C=25^\circ\text{C}$	80
		$T_C=100^\circ\text{C}$	40
Pulsed Collector Current, Limited by $T_{Jmax}$	$I_{CM}$	120	A
Turn off SOA, $V_{CE} \leq 650\text{V}$ , Limited by $T_{Jmax}$	$I_{LM}$	60	A
Power Dissipation	$P_D$	$T_C=25^\circ\text{C}$	260
		$T_C=100^\circ\text{C}$	105
Junction and Storage Temperature Range	$T_J, T_{STG}$	-55 to 150	$^\circ\text{C}$
Maximum lead temperature for soldering purpose, 1/8" from case for 5 seconds	$T_L$	300	$^\circ\text{C}$
<b>Thermal Characteristics</b>			
Parameter	Symbol	AOKS40B65H2AL	Units
Maximum Junction-to-Ambient	$R_{\theta JA}$	40	$^\circ\text{C/W}$
Maximum IGBT Junction-to-Case	$R_{\theta JC}$	0.48	$^\circ\text{C/W}$

**Electrical Characteristics (T<sub>J</sub>=25°C unless otherwise noted)**

Symbol	Parameter	Conditions	Min	Typ	Max	Units	
<b>STATIC PARAMETERS</b>							
BV <sub>CES</sub>	Collector-Emitter Breakdown Voltage	I <sub>C</sub> =1mA, V <sub>GE</sub> =0V, T <sub>J</sub> =25°C	650	-	-	V	
V <sub>CE(sat)</sub>	Collector-Emitter Saturation Voltage	V <sub>GE</sub> =15V, I <sub>C</sub> =40A	T <sub>J</sub> =25°C	-	2.05	2.6	V
			T <sub>J</sub> =125°C	-	2.57	-	
			T <sub>J</sub> =150°C	-	2.71	-	
V <sub>GE(th)</sub>	Gate-Emitter Threshold Voltage	V <sub>CE</sub> =5V, I <sub>C</sub> =1mA	-	4.7	-	V	
I <sub>CES</sub>	Zero Gate Voltage Collector Current	V <sub>CE</sub> =650V, V <sub>GE</sub> =0V	T <sub>J</sub> =25°C	-	-	10	μA
			T <sub>J</sub> =125°C	-	-	500	
			T <sub>J</sub> =150°C	-	-	5000	
I <sub>GES</sub>	Gate-Emitter leakage current	V <sub>CE</sub> =0V, V <sub>GE</sub> =±30V	-	-	±100	nA	
g <sub>FS</sub>	Forward Transconductance	V <sub>CE</sub> =20V, I <sub>C</sub> =40A	-	24	-	S	
<b>DYNAMIC PARAMETERS</b>							
C <sub>ies</sub>	Input Capacitance	V <sub>GE</sub> =0V, V <sub>CC</sub> =25V, f=1MHz	-	1275	-	pF	
C <sub>oes</sub>	Output Capacitance		-	88	-	pF	
C <sub>res</sub>	Reverse Transfer Capacitance		-	44	-	pF	
Q <sub>g</sub>	Total Gate Charge	V <sub>GE</sub> =15V, V <sub>CC</sub> =520V, I <sub>C</sub> =40A	-	61	-	nC	
Q <sub>ge</sub>	Gate to Emitter Charge		-	18	-	nC	
Q <sub>gc</sub>	Gate to Collector Charge		-	27	-	nC	
R <sub>g</sub>	Gate resistance	V <sub>GE</sub> =0V, V <sub>CC</sub> =0V, f=1MHz	-	11	-	Ω	
<b>SWITCHING PARAMETERS, (Load Inductive, T<sub>J</sub>=25°C)</b>							
T <sub>d(on)</sub>	Turn-On Delay Time	T <sub>J</sub> =25°C V <sub>GE</sub> =15V, V <sub>CC</sub> =400V, I <sub>C</sub> =40A, R <sub>G</sub> =7.5Ω E <sub>on</sub> and E <sub>total</sub> include diode (AOK40B65H2AL) reverse recovery	-	30	-	ns	
T <sub>r</sub>	Turn-On Rise Time		-	30	-	ns	
T <sub>d(off)</sub>	Turn-Off Delay Time		-	117	-	ns	
T <sub>f</sub>	Turn-Off Fall Time		-	16	-	ns	
E <sub>on</sub>	Turn-On Energy		-	1.17	-	mJ	
E <sub>off</sub>	Turn-Off Energy		-	0.54	-	mJ	
E <sub>total</sub>	Total Switching Energy		-	1.71	-	mJ	
<b>SWITCHING PARAMETERS, (Load Inductive, T<sub>J</sub>=150°C)</b>							
T <sub>d(on)</sub>	Turn-On Delay Time	T <sub>J</sub> =150°C V <sub>GE</sub> =15V, V <sub>CC</sub> =400V, I <sub>C</sub> =40A, R <sub>G</sub> =7.5Ω E <sub>on</sub> and E <sub>total</sub> include diode (AOK40B65H2AL) reverse recovery	-	29	-	ns	
T <sub>r</sub>	Turn-On Rise Time		-	35	-	ns	
T <sub>d(off)</sub>	Turn-Off Delay Time		-	133	-	ns	
T <sub>f</sub>	Turn-Off Fall Time		-	18	-	ns	
E <sub>on</sub>	Turn-On Energy		-	1.27	-	mJ	
E <sub>off</sub>	Turn-Off Energy		-	0.78	-	mJ	
E <sub>total</sub>	Total Switching Energy		-	2.06	-	mJ	

APPLICATIONS OR USE AS CRITICAL COMPONENTS IN LIFE SUPPORT DEVICES OR SYSTEMS ARE NOT AUTHORIZED. AOS DOES NOT ASSUME ANY LIABILITY ARISING OUT OF SUCH APPLICATIONS OR USES OF ITS PRODUCTS. AOS RESERVES THE RIGHT TO IMPROVE PRODUCT DESIGN, FUNCTIONS AND RELIABILITY WITHOUT NOTICE.

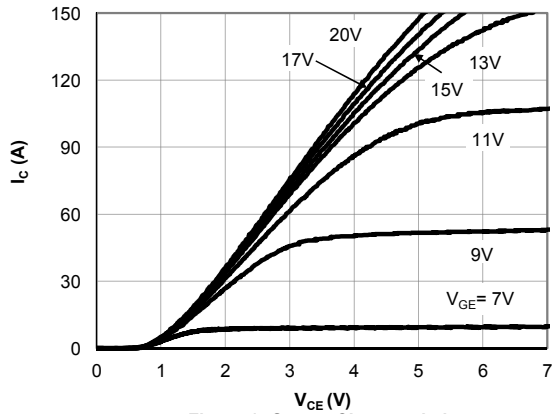
**TYPICAL ELECTRICAL AND THERMAL CHARACTERISTICS**


Figure 1: Output Characteristic  
( $T_j=25^\circ\text{C}$ )

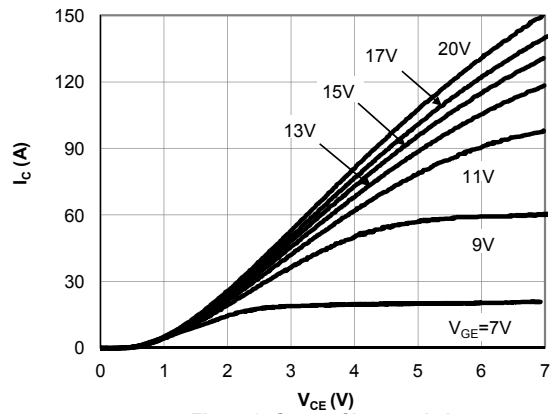


Figure 2: Output Characteristic  
( $T_j=150^\circ\text{C}$ )

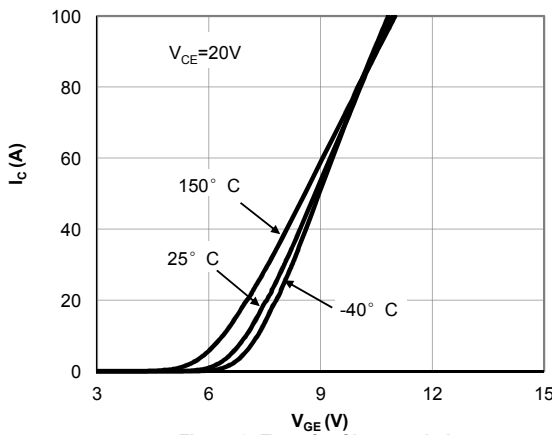


Figure 3: Transfer Characteristic

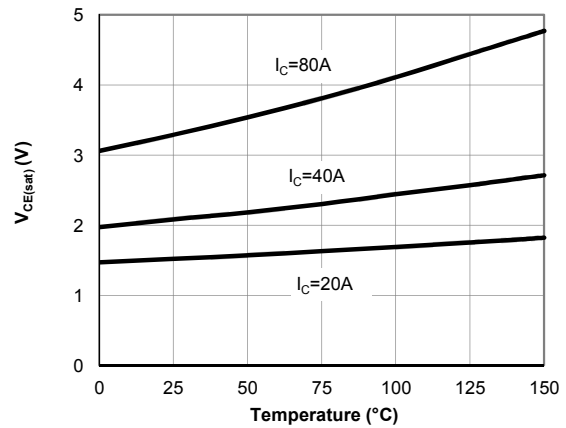


Figure 4: Collector-Emitter Saturation Voltage vs. Junction Temperature

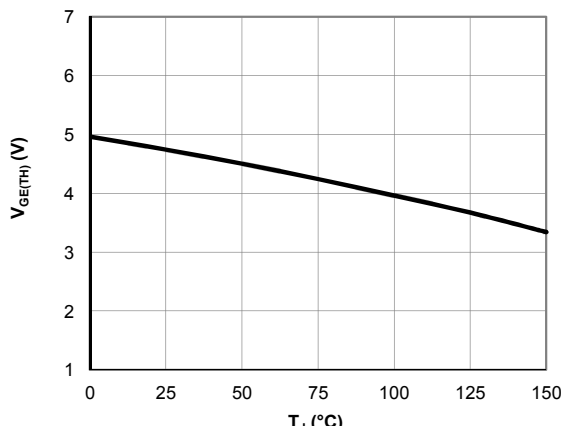
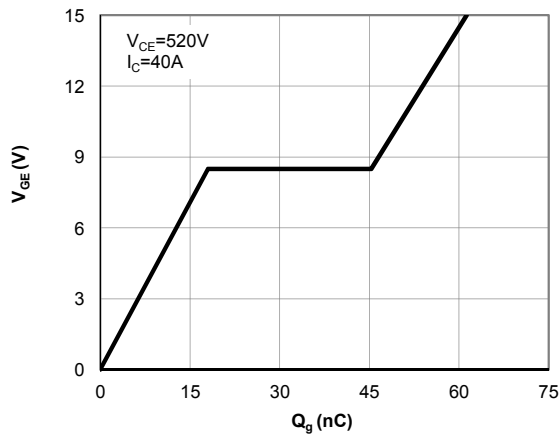
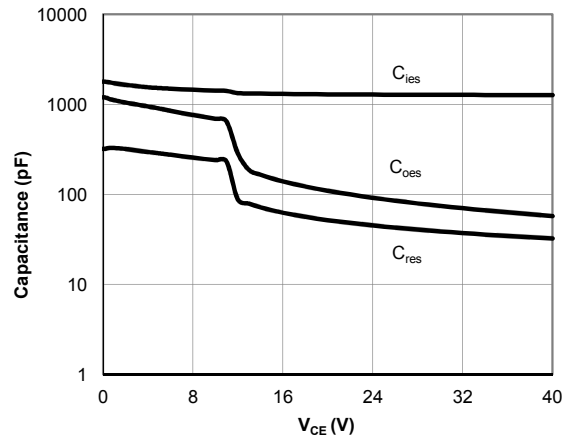
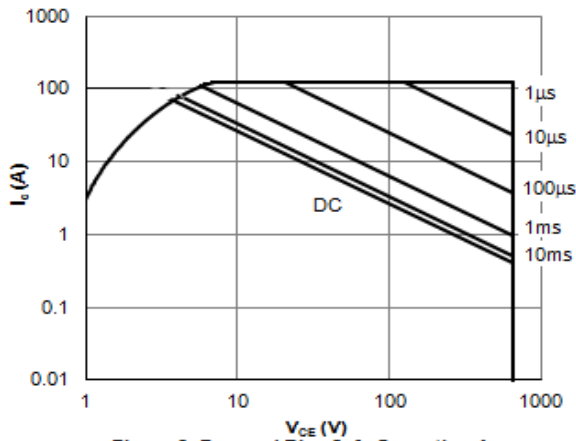
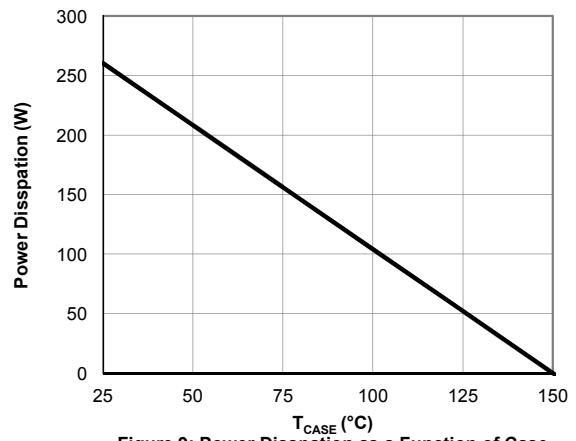
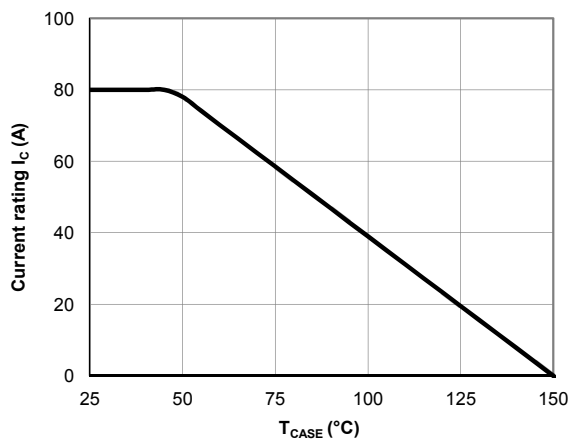
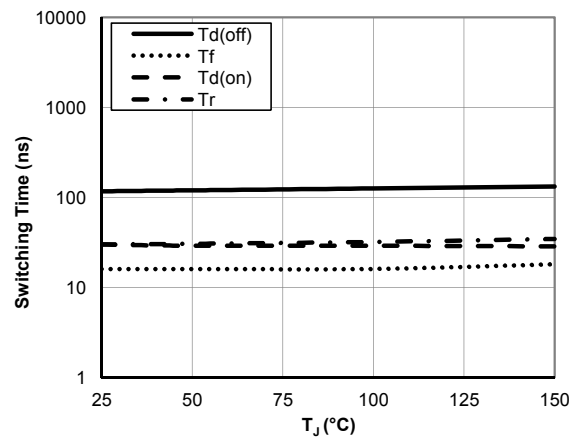


Figure 5:  $V_{GE(TH)}$  vs.  $T_j$

**TYPICAL ELECTRICAL AND THERMAL CHARACTERISTICS**

**Figure 6: Gate-Charge Characteristics**

**Figure 7: Capacitance Characteristic**

**Figure 8: Forward Bias Safe Operating Area**  
 ( $T_c=25^\circ\text{C}$ ,  $V_{GE}=15\text{V}$ )

**Figure 9: Power Dissipation as a Function of Case**

**Figure 10: Current De-rating**

**Figure 11: Switching Time vs.  $T_J$**   
 ( $V_{GE}=15\text{V}$ ,  $V_{CE}=400\text{V}$ ,  $I_C=40\text{A}$ ,  $R_\theta=7.5\Omega$ )

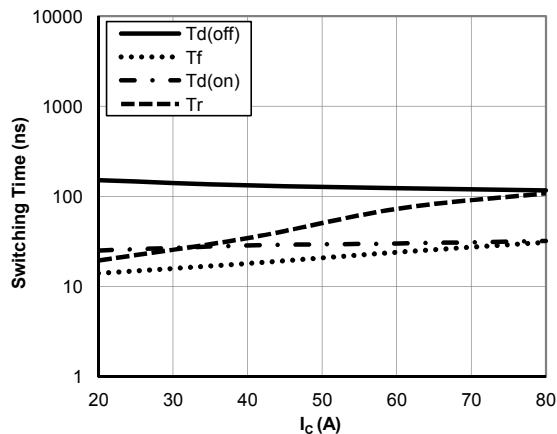
**TYPICAL ELECTRICAL AND THERMAL CHARACTERISTICS**


Figure 12: Switching Time vs.  $I_c$   
 ( $T_j=150^\circ\text{C}$ ,  $V_{GE}=15\text{V}$ ,  $V_{CE}=400\text{V}$ ,  $R_g=7.5\Omega$ )

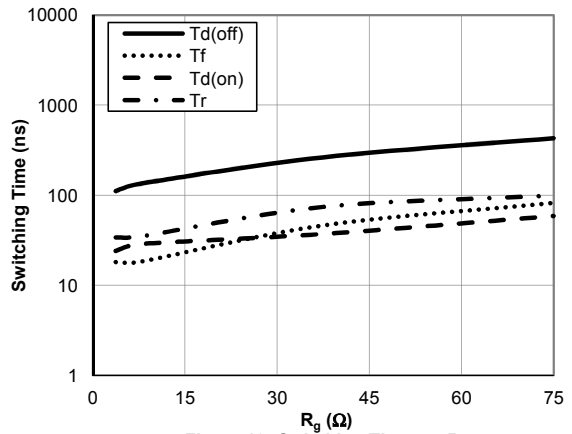


Figure 13: Switching Time vs.  $R_g$   
 ( $T_j=150^\circ\text{C}$ ,  $V_{GE}=15\text{V}$ ,  $V_{CE}=400\text{V}$ ,  $I_c=40\text{A}$ )

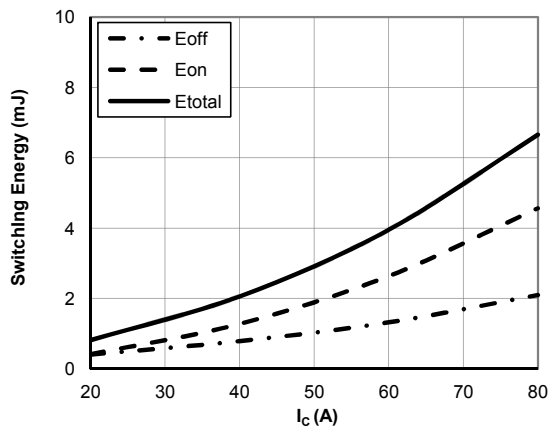


Figure 14: Switching Loss vs.  $I_c$   
 ( $T_j=150^\circ\text{C}$ ,  $V_{GE}=15\text{V}$ ,  $V_{CE}=400\text{V}$ ,  $R_g=7.5\Omega$ )

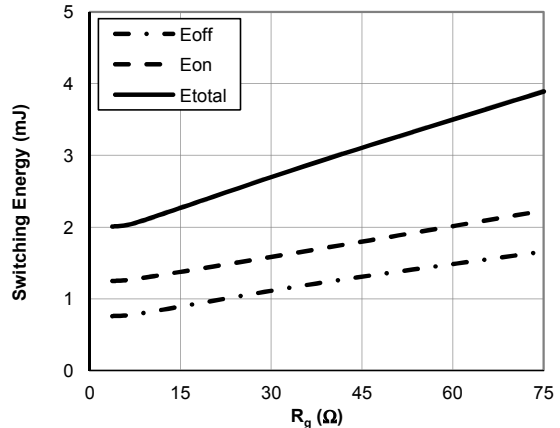


Figure 15: Switching Loss vs.  $R_g$   
 ( $T_j=150^\circ\text{C}$ ,  $V_{GE}=15\text{V}$ ,  $V_{CE}=400\text{V}$ ,  $I_c=40\text{A}$ )

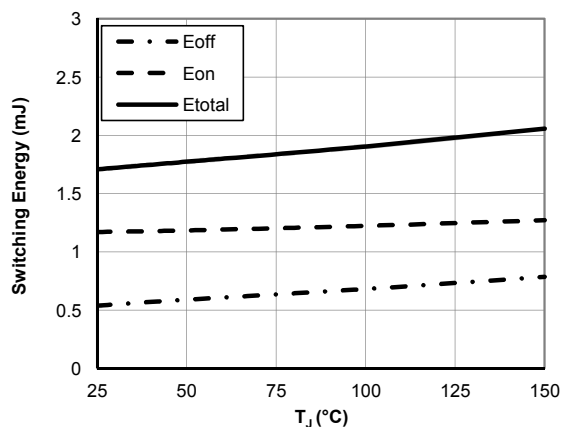


Figure 16: Switching Loss vs.  $T_j$   
 ( $V_{GE}=15\text{V}$ ,  $V_{CE}=400\text{V}$ ,  $I_c=40\text{A}$ ,  $R_g=7.5\Omega$ )

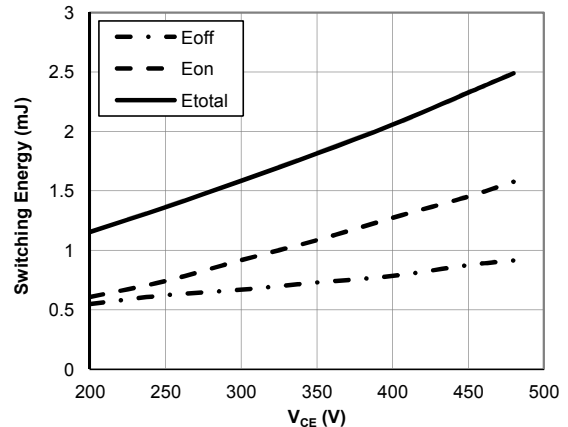
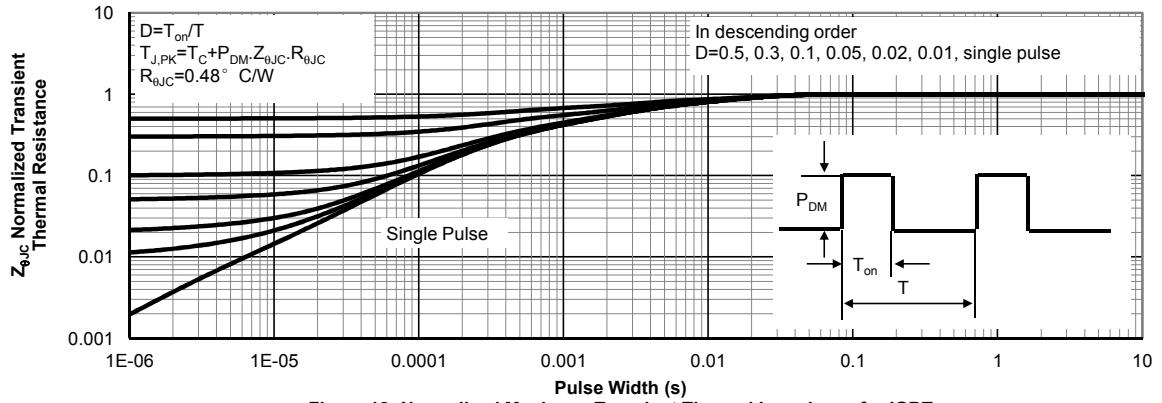


Figure 17: Switching Loss vs.  $V_{CE}$   
 ( $T_j=150^\circ\text{C}$ ,  $V_{GE}=15\text{V}$ ,  $I_c=40\text{A}$ ,  $R_g=7.5\Omega$ )

**TYPICAL ELECTRICAL AND THERMAL CHARACTERISTICS**



**Figure 18: Normalized Maximum Transient Thermal Impedance for IGBT**

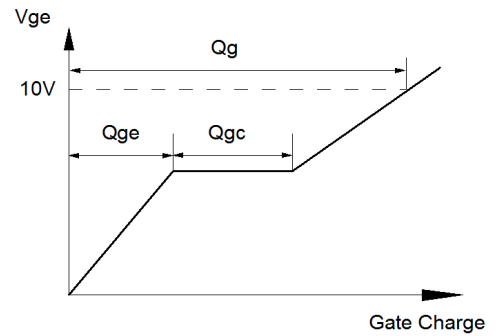
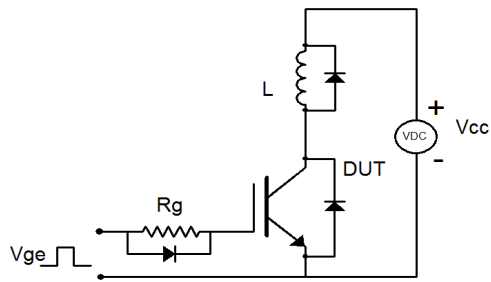


Figure A: Gate Charge Test Circuit & Waveforms

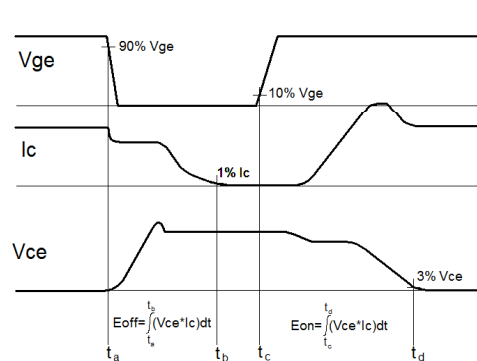
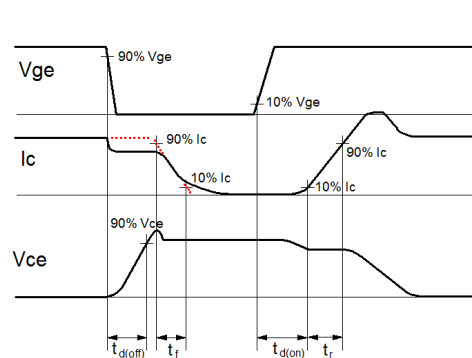
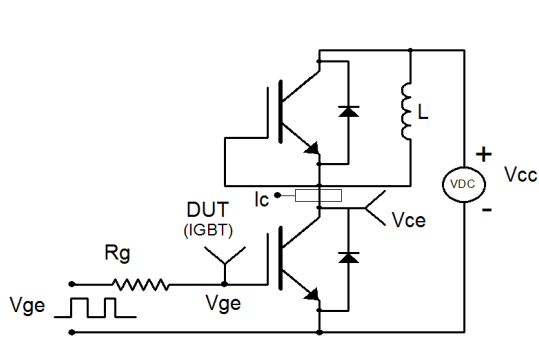


Figure B: Inductive Switching Test Circuit & Waveforms