

General Description <ul style="list-style-type: none"> • Latest Trench Power MOSFET technology • Very Low $R_{DS(ON)}$ at 4.5V V_{GS} • Low Gate Charge • High Current Capability • RoHS and Halogen-Free Compliant Application <ul style="list-style-type: none"> • System/Load Switch, Battery Switch 	Product Summary <table border="0" style="width: 100%;"> <tr> <td>V_{DS}</td> <td style="text-align: right;">-30V</td> </tr> <tr> <td>I_D (at $V_{GS}=-10V$)</td> <td style="text-align: right;">-32A</td> </tr> <tr> <td>$R_{DS(ON)}$ (at $V_{GS}=-10V$)</td> <td style="text-align: right;">< 8.5mΩ</td> </tr> <tr> <td>$R_{DS(ON)}$ (at $V_{GS}=-4.5V$)</td> <td style="text-align: right;">< 17mΩ</td> </tr> </table> Typical ESD protection <table border="0" style="width: 100%;"> <tr> <td>100% UIS Tested</td> <td style="text-align: right;">HBM Class 2</td> </tr> <tr> <td>100% Rg Tested</td> <td></td> </tr> </table> 	V_{DS}	-30V	I_D (at $V_{GS}=-10V$)	-32A	$R_{DS(ON)}$ (at $V_{GS}=-10V$)	< 8.5m Ω	$R_{DS(ON)}$ (at $V_{GS}=-4.5V$)	< 17m Ω	100% UIS Tested	HBM Class 2	100% Rg Tested	
V_{DS}	-30V												
I_D (at $V_{GS}=-10V$)	-32A												
$R_{DS(ON)}$ (at $V_{GS}=-10V$)	< 8.5m Ω												
$R_{DS(ON)}$ (at $V_{GS}=-4.5V$)	< 17m Ω												
100% UIS Tested	HBM Class 2												
100% Rg Tested													

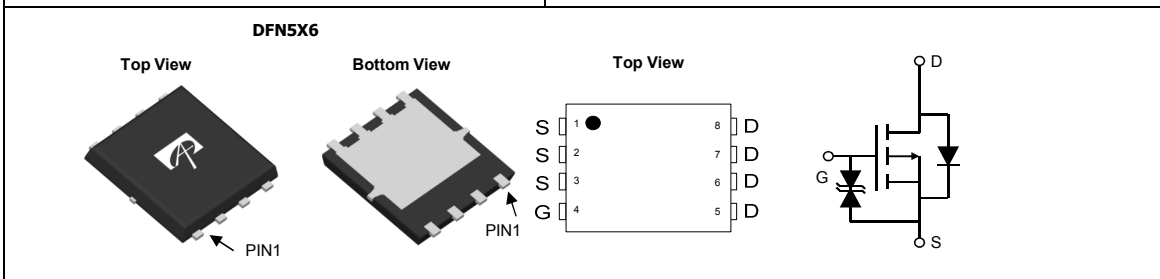

Orderable Part Number	Package Type	Form	Minimum Order Quantity
AON6413	DFN 5x6	Tape & Reel	3000

Absolute Maximum Ratings $T_A=25^\circ\text{C}$ unless otherwise noted

Parameter	Symbol	Maximum	Units
Drain-Source Voltage	V_{DS}	-30	V
Gate-Source Voltage	V_{GS}	± 25	V
Continuous Drain Current ^G	I_D	$T_C=25^\circ\text{C}$	-32
		$T_C=100^\circ\text{C}$	-25
Pulsed Drain Current ^C	I_{DM}	-128	A
Continuous Drain Current	I_{DSM}	$T_A=25^\circ\text{C}$	-22
		$T_A=70^\circ\text{C}$	-17
Avalanche Current ^C	I_{AS}	-40	A
Avalanche energy	E_{AS}	80	mJ
V_{DS} Spike	V_{SPIKE}	-36	V
Power Dissipation ^B	P_D	$T_C=25^\circ\text{C}$	48
		$T_C=100^\circ\text{C}$	19
Power Dissipation ^A	P_{DSM}	$T_A=25^\circ\text{C}$	6.2
		$T_A=70^\circ\text{C}$	4.0
Junction and Storage Temperature Range	T_J, T_{STG}	-55 to 150	$^\circ\text{C}$

Thermal Characteristics

Parameter	Symbol	Typ	Max	Units
Maximum Junction-to-Ambient ^A	$R_{\theta JA}$	15	20	$^\circ\text{C}/\text{W}$
Maximum Junction-to-Ambient ^{A D}		40	50	$^\circ\text{C}/\text{W}$
Maximum Junction-to-Case	$R_{\theta JC}$	2.1	2.6	$^\circ\text{C}/\text{W}$

Electrical Characteristics (T_J=25°C unless otherwise noted)

Symbol	Parameter	Conditions	Min	Typ	Max	Units
STATIC PARAMETERS						
BV _{DSS}	Drain-Source Breakdown Voltage	I _D =-250μA, V _{GS} =0V	-30			V
I _{DSS}	Zero Gate Voltage Drain Current	V _{DS} =-30V, V _{GS} =0V T _J =55°C			-1 -5	μA
I _{GSS}	Gate-Body leakage current	V _{DS} =0V, V _{GS} =±25V			±10	μA
V _{GS(th)}	Gate Threshold Voltage	V _{DS} =V _{GS} , I _D =-250μA	-1.6	-2.1	-2.7	V
R _{DS(ON)}	Static Drain-Source On-Resistance	V _{GS} =-10V, I _D =-16A T _J =125°C		6.9	8.5	mΩ
		V _{GS} =-4.5V, I _D =-10A		9.8	12	
g _{FS}	Forward Transconductance	V _{DS} =-5V, I _D =-16A		-47		S
V _{SD}	Diode Forward Voltage	I _S =-1A, V _{GS} =0V		-0.7	-1	V
I _S	Maximum Body-Diode Continuous Current ^G				-32	A
DYNAMIC PARAMETERS						
C _{iss}	Input Capacitance	V _{GS} =0V, V _{DS} =-15V, f=1MHz		2142		pF
C _{oss}	Output Capacitance			474		pF
C _{rss}	Reverse Transfer Capacitance			363		pF
R _g	Gate resistance	f=1MHz		2.3	4.6	Ω
SWITCHING PARAMETERS						
Q _{g(10V)}	Total Gate Charge	V _{GS} =-10V, V _{DS} =-15V, I _D =-16A		41	58	nC
Q _{g(4.5V)}	Total Gate Charge			18.5	27	nC
Q _{gs}	Gate Source Charge			15		nC
Q _{gd}	Gate Drain Charge			6		nC
t _{D(on)}	Turn-On DelayTime	V _{GS} =-10V, V _{DS} =-15V, R _L =0.9Ω, R _{GEN} =3Ω		13		ns
t _r	Turn-On Rise Time			12		ns
t _{D(off)}	Turn-Off DelayTime			34		ns
t _f	Turn-Off Fall Time			18.5		ns
t _{rr}	Body Diode Reverse Recovery Time	I _F =-16A, di/dt=500A/μs		17.5		ns
Q _{rr}	Body Diode Reverse Recovery Charge	I _F =-16A, di/dt=500A/μs		44.5		nC

A. The value of R_{θJA} is measured with the device mounted on 1in² FR-4 board with 2oz. Copper, in a still air environment with T_A=25° C. The Power dissipation P_{DSM} is based on R_{θJA} ≤ 10s and the maximum allowed junction temperature of 150° C. The value in any given application depends on the user's specific board design.

B. The power dissipation P_D is based on T_{J(MAX)}=150° C, using junction-to-case thermal resistance, and is more useful in setting the upper dissipation limit for cases where additional heatsinking is used.

C. Single pulse width limited by junction temperature T_{J(MAX)}=150° C.

D. The R_{θJA} is the sum of the thermal impedance from junction to case R_{θJC} and case to ambient.

E. The static characteristics in Figures 1 to 6 are obtained using <300μs pulses, duty cycle 0.5% max.

F. These curves are based on the junction-to-case thermal impedance which is measured with the device mounted to a large heatsink, assuming a maximum junction temperature of T_{J(MAX)}=150° C. The SOA curve provides a single pulse rating.

G. The maximum current rating is package limited.

H. These tests are performed with the device mounted on 1 in² FR-4 board with 2oz. Copper, in a still air environment with T_A=25° C.

THIS PRODUCT HAS BEEN DESIGNED AND QUALIFIED FOR THE CONSUMER MARKET. APPLICATIONS OR USES AS CRITICAL COMPONENTS IN LIFE SUPPORT DEVICES OR SYSTEMS ARE NOT AUTHORIZED. AOS DOES NOT ASSUME ANY LIABILITY ARISING OUT OF SUCH APPLICATIONS OR USES OF ITS PRODUCTS. AOS RESERVES THE RIGHT TO IMPROVE PRODUCT DESIGN, FUNCTIONS AND RELIABILITY WITHOUT NOTICE.

TYPICAL ELECTRICAL AND THERMAL CHARACTERISTICS

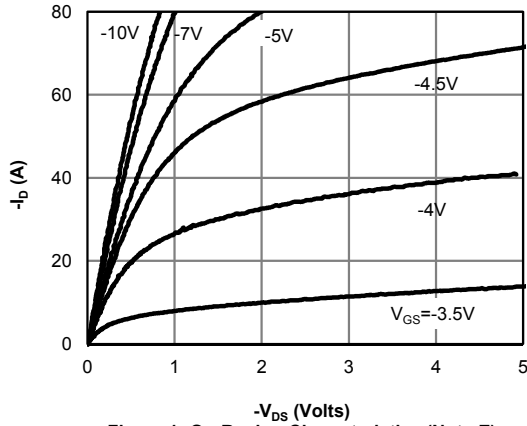

Figure 1: On-Region Characteristics (Note E)

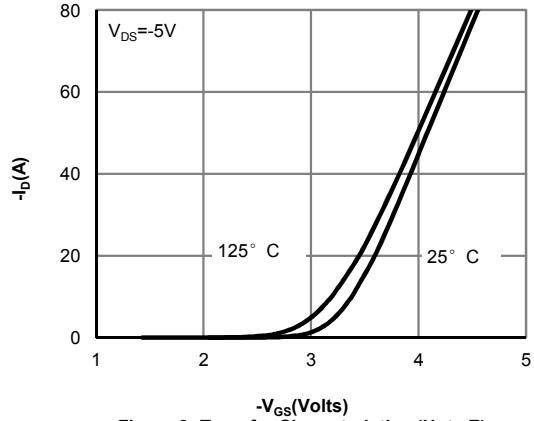

Figure 2: Transfer Characteristics (Note E)

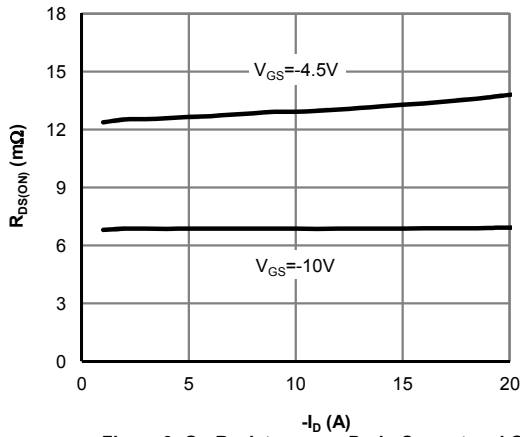

Figure 3: On-Resistance vs. Drain Current and Gate Voltage (Note E)

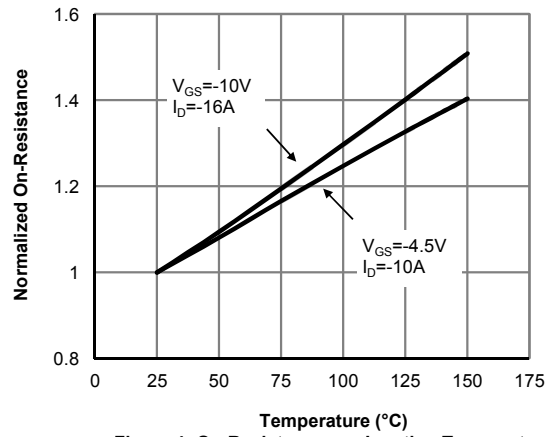

Figure 4: On-Resistance vs. Junction Temperature (Note E)

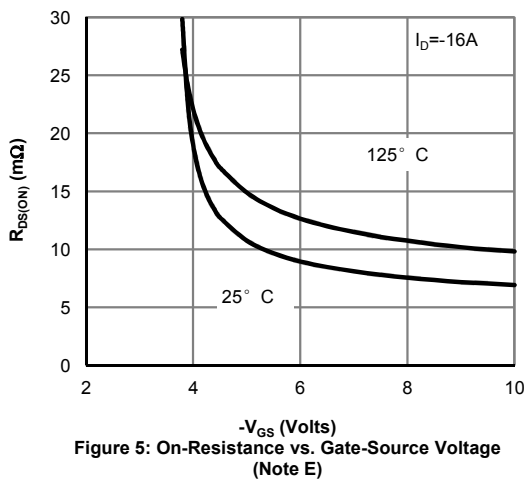

Figure 5: On-Resistance vs. Gate-Source Voltage (Note E)

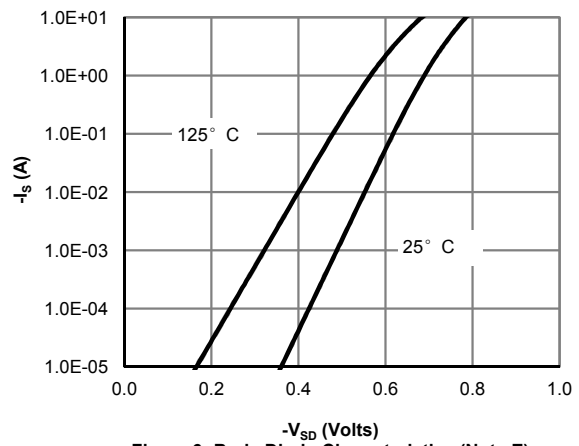

Figure 6: Body-Diode Characteristics (Note E)

TYPICAL ELECTRICAL AND THERMAL CHARACTERISTICS

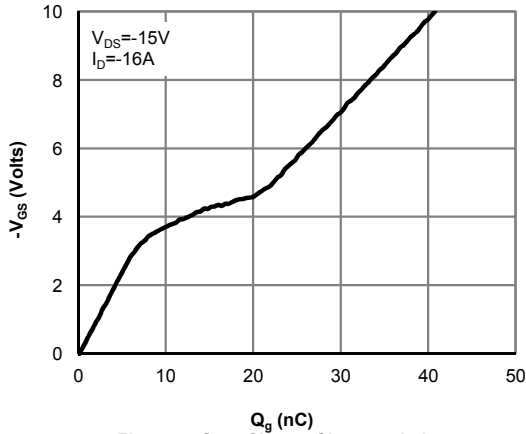

Figure 7: Gate-Charge Characteristics

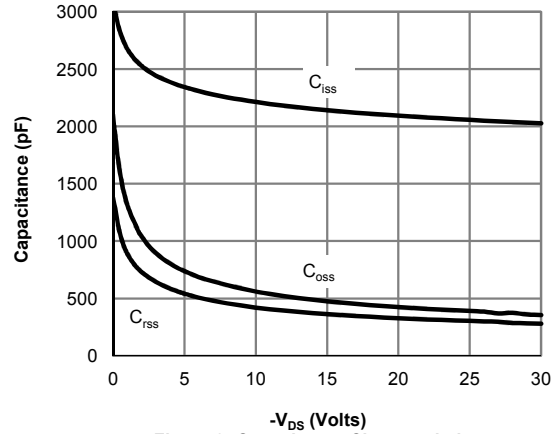

Figure 8: Capacitance Characteristics

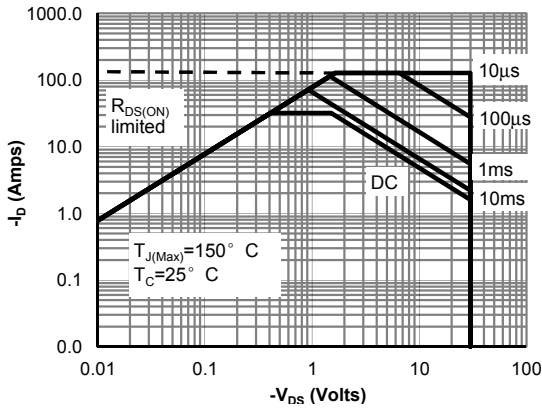

Figure 9: Maximum Forward Biased Safe Operating Area (Note F)
 $V_{GS} > \text{or equal to } 4.5V$

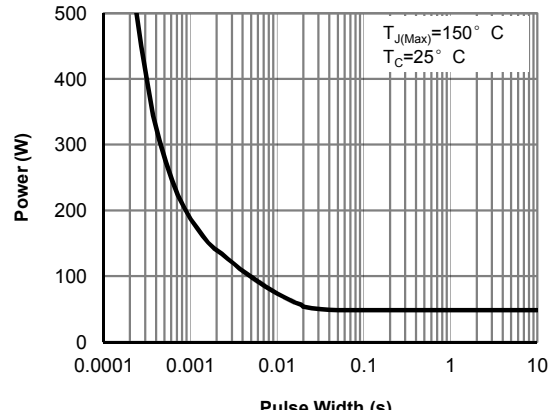

Figure 10: Single Pulse Power Rating Junction-to-Case (Note F)

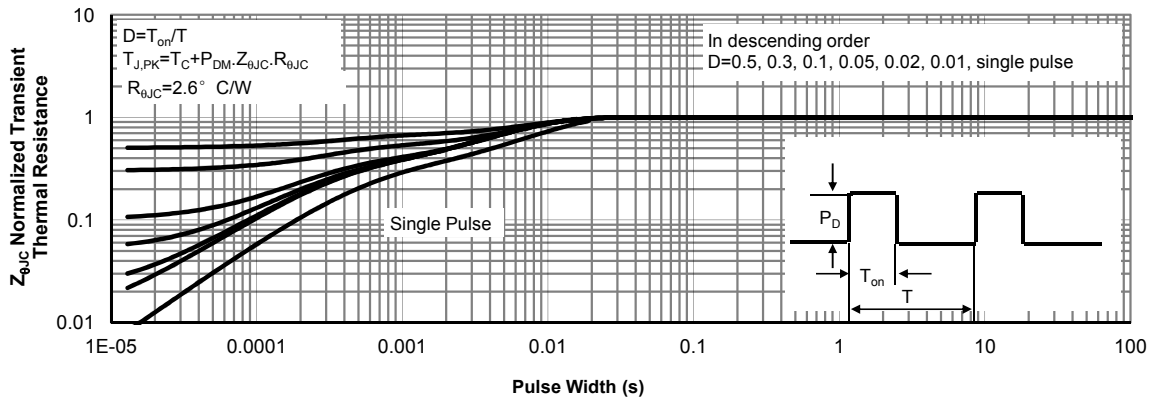

Figure 11: Normalized Maximum Transient Thermal Impedance (Note F)

TYPICAL ELECTRICAL AND THERMAL CHARACTERISTICS

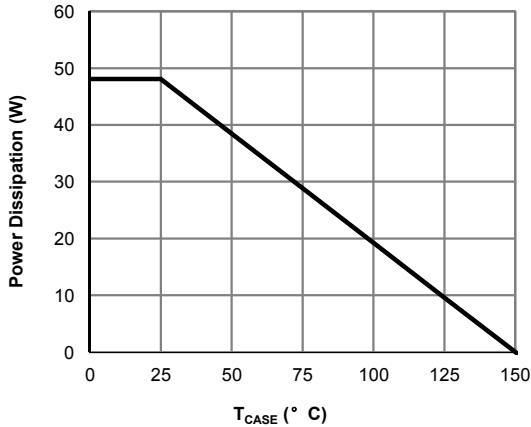

Figure 12: Power De-rating (Note F)

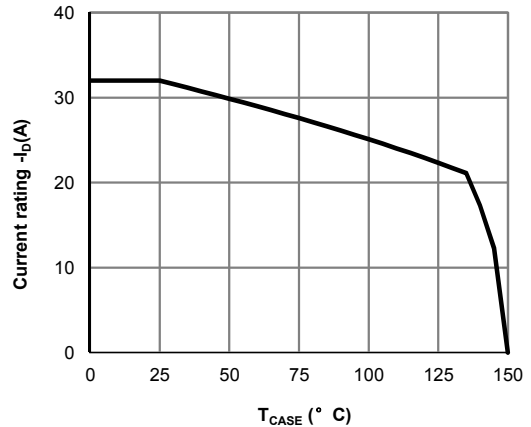

Figure 13: Current De-rating (Note F)

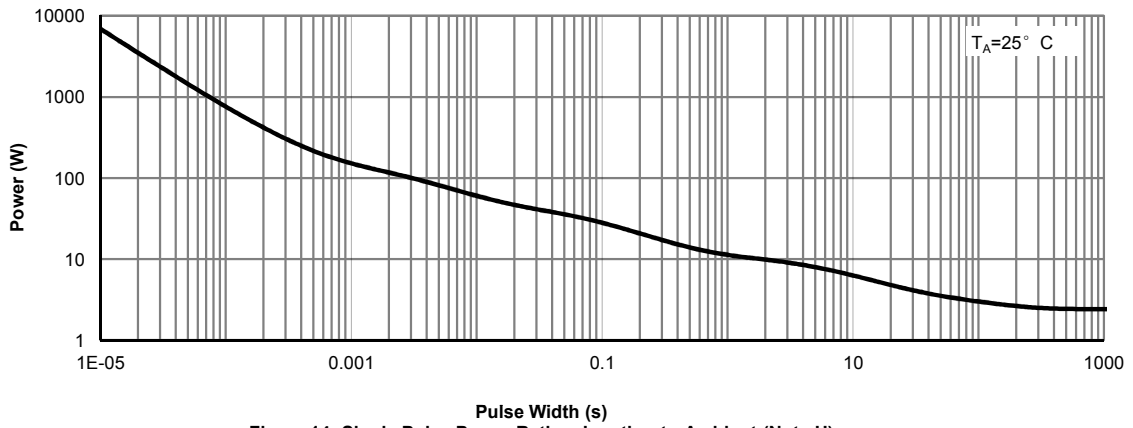

Figure 14: Single Pulse Power Rating Junction-to-Ambient (Note H)

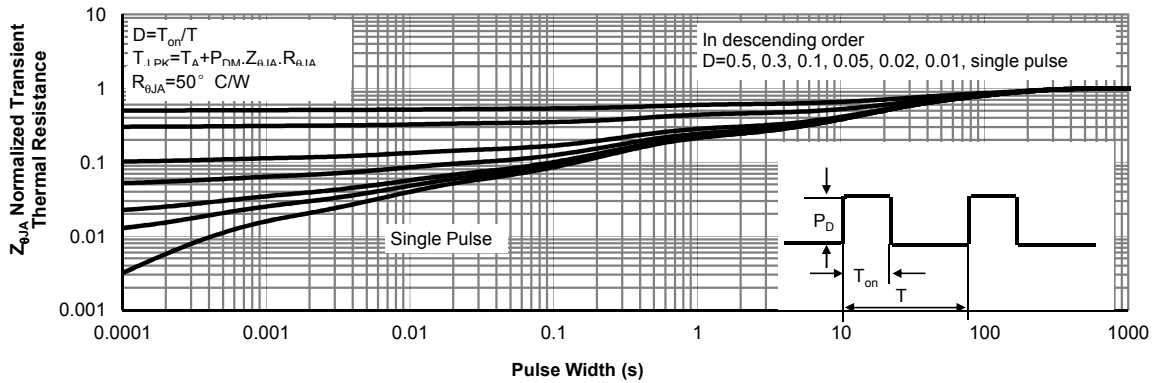
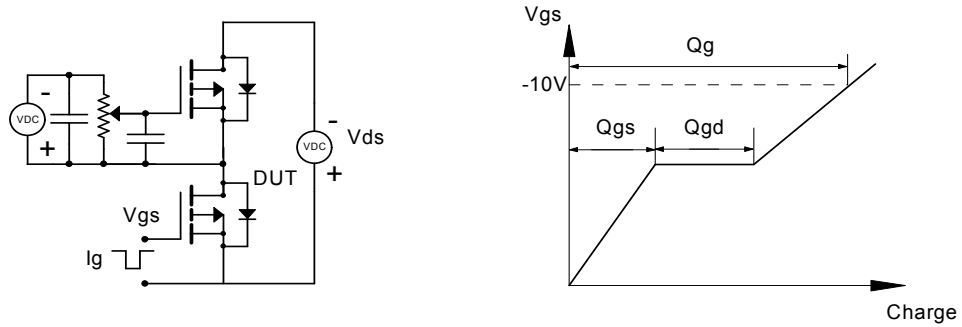
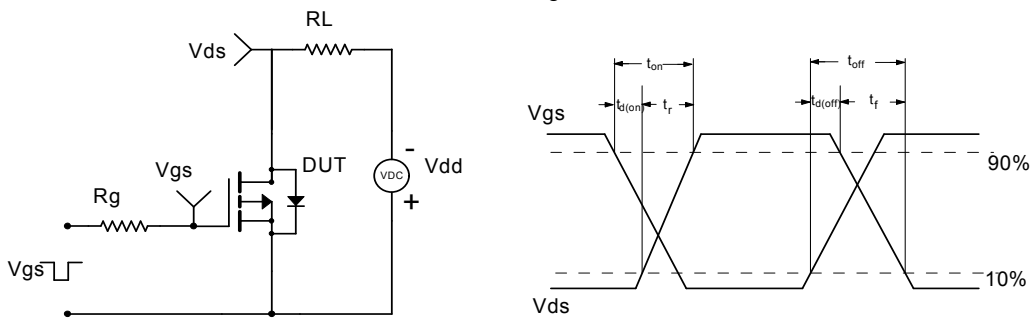

Figure 15: Normalized Maximum Transient Thermal Impedance (Note H)

Gate Charge Test Circuit & Waveform



Resistive Switching Test Circuit & Waveforms



Unclamped Inductive Switching (UIS) Test Circuit & Waveforms

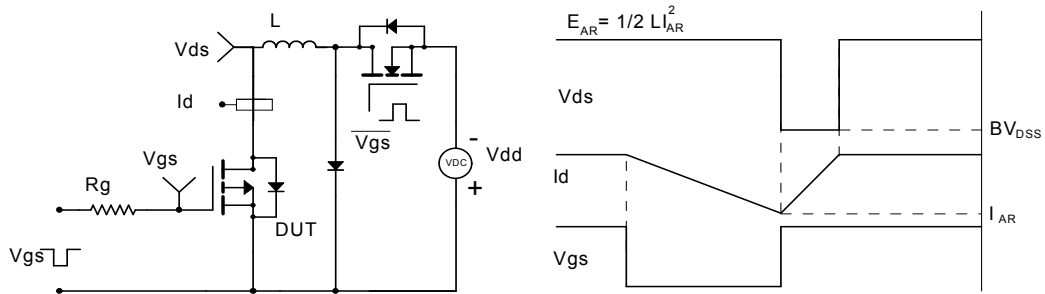

Diode Recovery Test Circuit & Waveforms

