

General Description

The AOZ8S322UD2-03 is a 2-channel unidirectional low capacitance transient voltage suppressor designed to protect data lines such as USB2.0 and low speed signal lines from damaging ESD or surge events.

This device incorporates two unidirectional TVS diodes in a single package. During transient conditions, the TVS diodes direct the transient to either the positive side of the power supply line or to ground.

The AOZ8S322UD2-03 provides a typical I/O to GND capacitance of 0.55 pF and low clamping voltage making it ideally suited for data transmission protection in mobile and computing devices.

The AOZ8S322UD2-03 comes in a RoHS compliant and Halogen Free 1.0mmx0.6mm package and is rated for -40°C to +125°C junction temperature range.

Features

- ESD protection for high-speed data lines:
 - IEC 61000-4-2 (ESD) immunity:
 - Air discharge: ± 30 kV
 - Contact discharge: ± 30 kV
 - IEC 61000-4-5 (Lightning, 8/20 μ s) 9 A
- Low capacitance between I/O to GND: 0.55 pF
- Low surge clamping voltage
- Low operating voltage: 3.3V

Applications

- USB2.0
- USB Type-C
- Mobile phone
- Notebook computers



Typical Applications

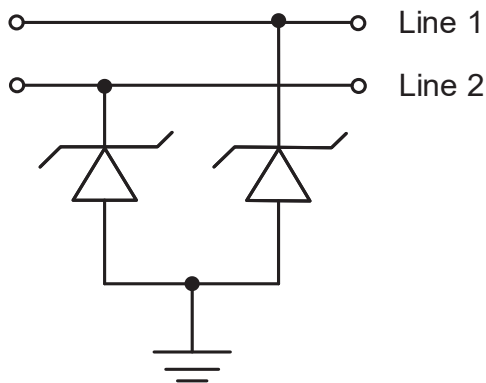

Pin Configuration

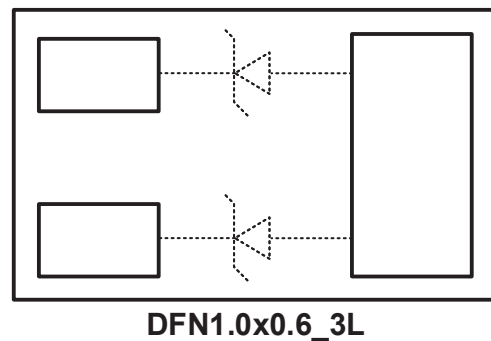

Ordering Information

Part Number	Ambient Temperature Range	Package	Environmental
AOZ8S322UD2-03	-40°C to +125°C	DFN1.0×0.6-3L	Green Product



AOS Green Products use reduced levels of Halogens, and are also RoHS compliant. Please visit www.aosmd.com/media/AOSGreenPolicy.pdf for additional information.

Absolute Maximum Ratings

Exceeding the Absolute Maximum Ratings may damage the device.

Parameter	Rating
Storage Temperature (T _S)	-65 °C to +150 °C
ESD Rating per Human Body Mode (HMB) ⁽¹⁾	±8 kV
ESD Rating per IEC61000-4-2, contact ⁽²⁾	±30 kV
ESD Rating per IEC61000-4-2, air ⁽²⁾	±30 kV
Surge Rating per IEC61000-4-5, 8/20µs	±9 A

Notes:

- Human Body Discharge per MIL-STD-883, Method 3015 C_{Discharge} = 100 pF, R_{Discharge} = 1.5 kΩ
- IEC 61000-4-2 discharge with C_{Discharge} = 150 pF, R_{Discharge} = 330 Ω.

Maximum Operating Ratings

Parameter	Rating
Junction Temperature (T _J)	-40 °C to +125 °C

Electrical Characteristics

T_A = 25°C, unless otherwise noted. I/O Pin to GND.

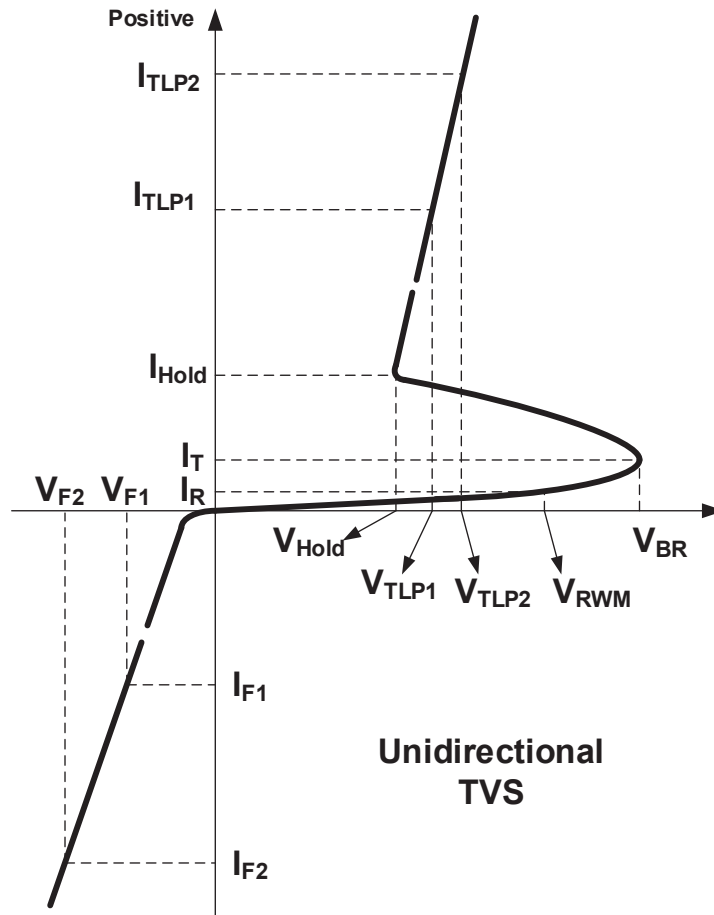

Symbol	Parameter	Conditions	Min	Typ	Max	Units
V _{RWM}	Reverse Working Voltage				3.3	V
V _{BR}	Reverse Breakdown Voltage	I _T = 100 μA	6	9	12	
I _R	Reverse Leakage Current	V _T =Max. V _{RWM}		1	100	nA
V _{CL}	Clamping Voltage ⁽³⁾⁽⁴⁾ (100 ns Transmission Line Pulse)	I _{TLP} = 1 A I _{TLP} = -1 A		1.4 -1.2	2 -2	V
		I _{TLP} = 16 A I _{TLP} = -16 A		4.5 -6	5.5 -7	
		I _{TLP} = 30 A I _{TLP} = -30 A		7.5 -10.5	8.5 -11.5	
	Clamping Voltage ⁽³⁾ IEC61000-4-5 Surge 8/20μs	I _{PP} = 1 A I _{PP} = -1 A		2 -2	3 -3	V
I _{PP} = 9 A I _{PP} = -9 A			4.5 -6	5.5 -7		
C _J	Junction Capacitance	V _{I/O} = 1.5 V, f = 1 MHz		0.55	0.95	pF

Notes:

- 3. These specifications are guaranteed by design and characterization.
- 4. Measurements performed using a 100ns Transmission Line Pulse (TLP) system.

Typical Performance Characteristics

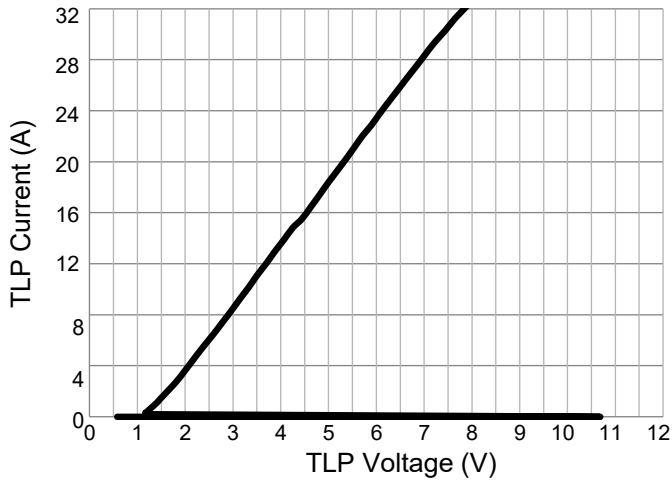

Figure 1. Positive Transmission Line Pulse (tp=100ns, tr=0.2ns)

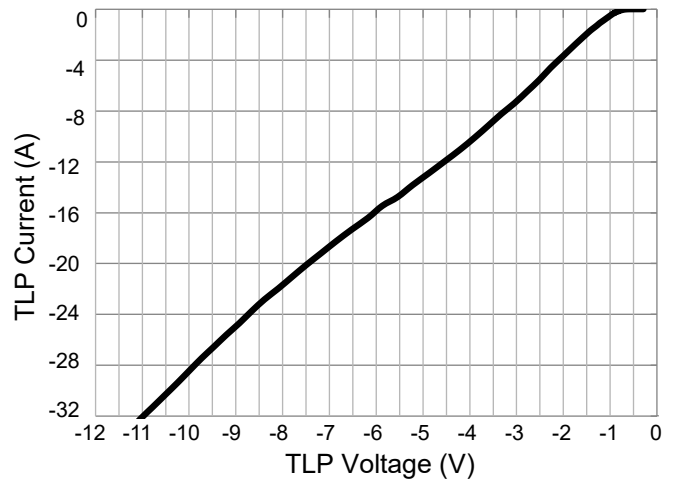

Figure 2. Negative Transmission Line Pulse (tp=100ns, tr=0.2ns)

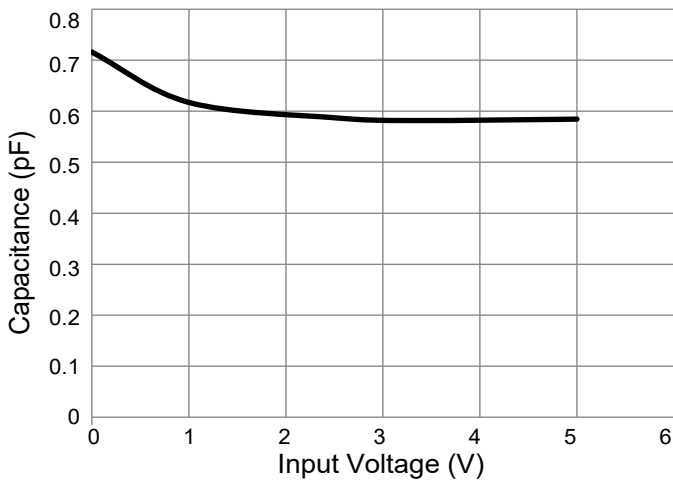

Figure 3. Typical Variations of CJ vs. Input Voltage

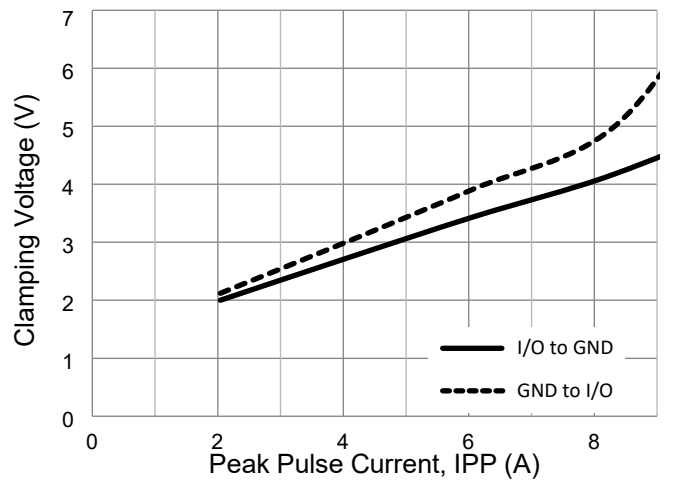

Figure 4. IEC61000-4-5 Surge 8/20us

LEGAL DISCLAIMER

Applications or uses as critical components in life support devices or systems are not authorized. Alpha and Omega Semiconductor does not assume any liability arising out of such applications or uses of its products. AOS reserves the right to make changes to product specifications without notice. It is the responsibility of the customer to evaluate suitability of the product for their intended application. Customer shall comply with applicable legal requirements, including all applicable export control rules, regulations and limitations.

AOS' products are provided subject to AOS' terms and conditions of sale which are set forth at:
http://www.aosmd.com/terms_and_conditions_of_sale

LIFE SUPPORT POLICY

ALPHA AND OMEGA SEMICONDUCTOR PRODUCTS ARE NOT AUTHORIZED FOR USE AS CRITICAL COMPONENTS IN LIFE SUPPORT DEVICES OR SYSTEMS.

As used herein:

1. Life support devices or systems are devices or systems which, (a) are intended for surgical implant into the body or (b) support or sustain life, and (c) whose failure to perform when properly used in accordance with instructions for use provided in the labeling, can be reasonably expected to result in a significant injury of the user.
2. A critical component in any component of a life support, device, or system whose failure to perform can be reasonably expected to cause the failure of the life support device or system, or to affect its safety or effectiveness.