

General Description

The AOZ2151EQI (-30, -31) is a high-efficiency, easy-to-use DC/DC synchronous buck regulator that operates up to 28V. The device is capable of supplying 4A of continuous output current with an output voltage adjustable down to 0.8V \pm 1.0%.

The AOZ2151EQI integrates an internal linear regulator to generate 5.3V VCC from input. If input voltage is lower than 5.3V, the linear regulator operates at low drop output mode, which allows the VCC voltage is equal to input voltage minus the drop-output voltage of the internal linear regulator.

The AOZ2151EQI EVB proprietary constant on-time PWM control with input feed-forward results in ultra-fast transient response while maintaining relatively constant switching frequency over the entire input voltage range.

The AOZ2151EQI EVB features multiple protection functions such as VCC under-voltage lockout, cycle-by-cycle current limit, output over-voltage protection, short-circuit protection, and thermal shutdown.

The AOZ2151EQI EVB demonstrates the COT buck converter design.

Features include: wide input voltage range 6.5V to 28V; 4A continuous output current; output voltage adjustable down to 0.8V (\pm 1.0%); low RDS(ON) internal NFETs with 28m Ω high-side and 28m Ω low-side; Constant On-Time with input feed-forward; ceramic capacitor stable; adjustable soft start; integrated bootstrap diode; cycle-by-cycle current limit; short circuit protection; and thermal shutdown.

Applications include: compact desktop PCs; graphics cards; set-top boxes; LCD TVs; cable modems; point-of-load DC/DC converters; and telecom/networking/datacom equipment.

Evaluation Board Schematic

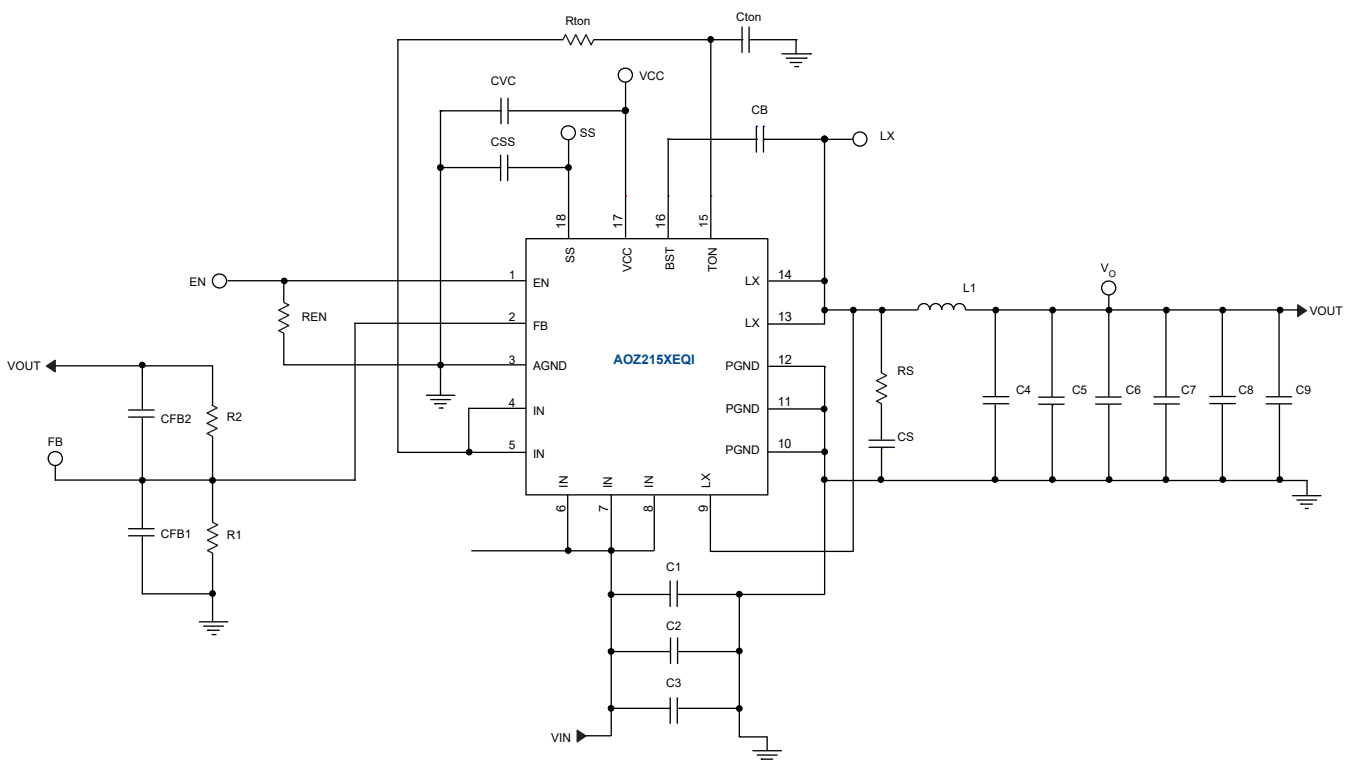

Table 1. AOZ2151EQI 12 Vin to 1.8 Vout Component List

Ref Designation	Part Number	Description
R1	10K	Res,10K, 0603, 1%, 1/10W
R2	12.7K	Res,12.7K, 0603, 1%, 1/10W
REN2	100K	Res, 100K, 0603, 1%, 1/10W
RTON	510K	Res, 510K, 0603, 1%, 1/10W
C2,C3	CL31A106KBHNNNE	Cap, 10µF 1210 50V X5R 10%
C4,C5,C6,C7	CC5X226M8	Cap, 22µF 1206 25V X5R 10%
CB,CEN	GRM188R71H104KA01D	Cap, 100nF 0603 50V X7R 10%
CTON	GRM188R71H101KA01D	Cap, 100pF 0603 50V X7R 10%
CSS	GRM188R71H103KA01D	Cap, 10nF 0603 50V X7R 10%
CVC	GRM188R61H475KALD	Cap, 4.7µF 0603 50V X5R 10%
L1	PI07050-1R5	Inductor,1.5µH
U1	AOZ2151EQI-XX	IC, QFN3X3
RS,CS,Cfb1,Cfb2,CVC2,C1,C8,C9		Open

Output voltage is set by R2: $R2 = R1 \cdot (V_{out} - 0.8) / 0.8$. Table 1 shows the value of the R2 typical output voltage.

Switching frequency estimation formula:

$$F_{SW}(\text{kHz}) = \frac{V_{out}(\text{V})}{R_{TON}(\text{k}\Omega)} \times 12 \times 10^4$$

Table 2. Option Table

Part Number	All Protection		PFM / Force PWM for Light Load		Package 3mmx3mm
	Hiccup Mode & Restart	Latch	PFM	Force PWM	QFN-18L
AOZ2151EQI-30	V		V		V
AOZ2151EQI-31	V			V	V

PCB Layout

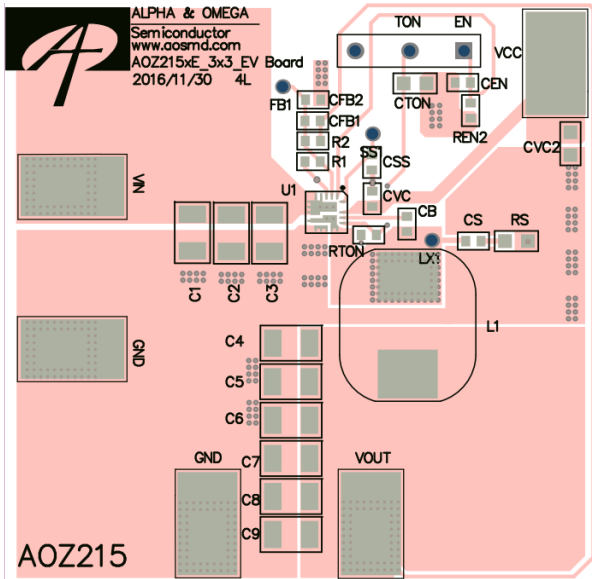

Figure 1. Top Layer

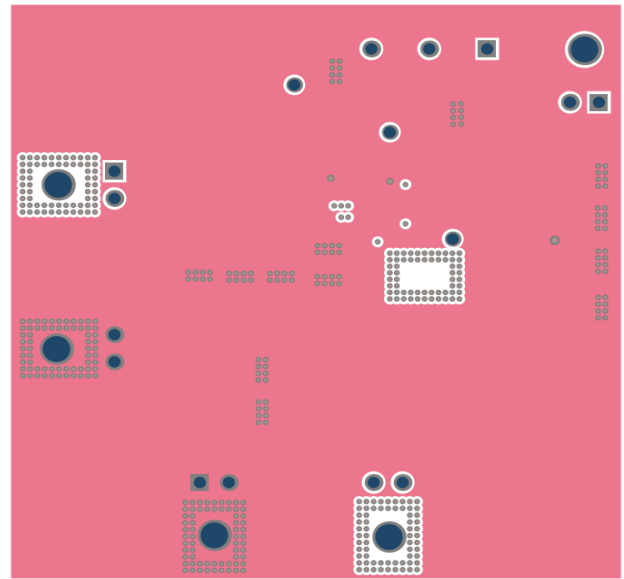

Figure 2. IN2-GND Layer

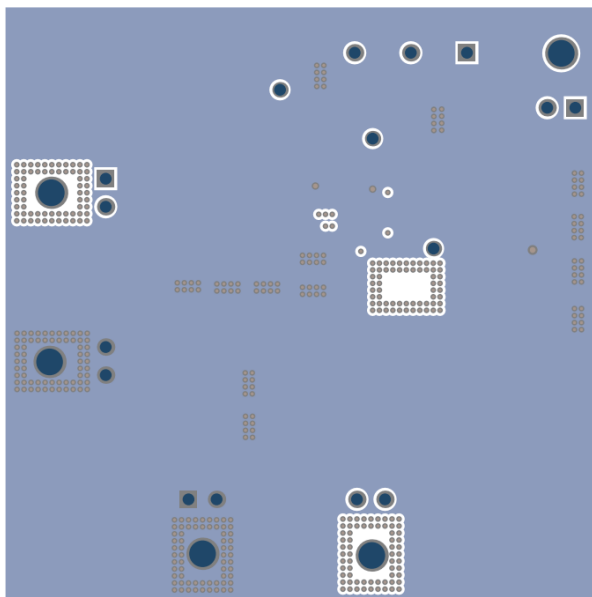

Figure 3. IN3-GND Layer

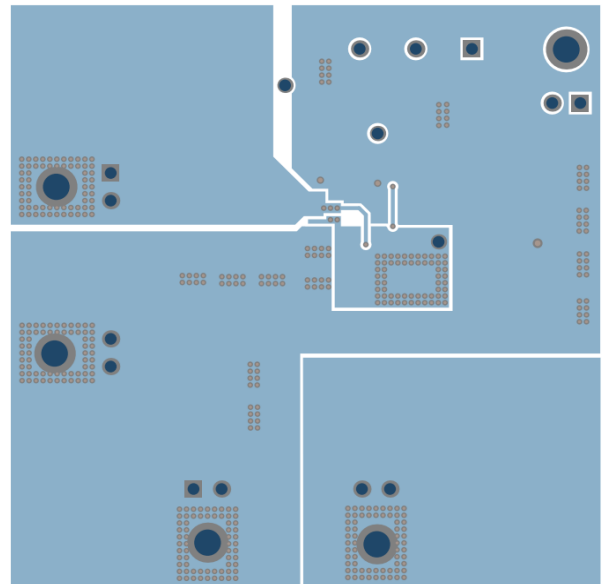

Figure 4. BOT Layer

Quick Start Guide

1. Connect the terminals of load to VOUT and GND connectors.
2. Connect the DC power supply to VIN and GND connects. Set the DC power supply voltage between the operating range of 6.5V and 28V.
3. Connect the DC power supply to EN and GND connects. Set the DC power supply voltage between the operating range of 3.3V and 5.5V.
4. Measure input voltage at the VIN and GND connectors to eliminate the effect of voltage drop on wire between the DC power supply and the evaluation board.
5. Measure output voltage at the VOUT and GND connectors to eliminate the effect of voltage drop on wire between load and evaluation board.
6. Use oscilloscope to monitor input ripple voltage across input capacitor C1.
7. Use oscilloscope to monitor output ripple voltage across output capacitor C7.
8. When monitoring the LX switching waveform, directly probe across the LX-PGND trace to minimize inductive ringing.

Note:

1. When testing the ripple voltage, remove the cap of the voltage probe and touch the probe tip directly across the Vin or Vout and GND terminals.

LEGAL DISCLAIMER

Applications or uses as critical components in life support devices or systems are not authorized. Alpha and Omega Semiconductor does not assume any liability arising out of such applications or uses of its products. AOS reserves the right to make changes to product specifications without notice. It is the responsibility of the customer to evaluate suitability of the product for their intended application. Customer shall comply with applicable legal requirements, including all applicable export control rules, regulations and limitations.

AOS' products are provided subject to AOS' terms and conditions of sale which are set forth at:

http://www.aosmd.com/terms_and_conditions_of_sale

LIFE SUPPORT POLICY

ALPHA AND OMEGA SEMICONDUCTOR PRODUCTS ARE NOT AUTHORIZED FOR USE AS CRITICAL COMPONENTS IN LIFE SUPPORT DEVICES OR SYSTEMS.

As used herein:

1. Life support devices or systems are devices or systems which, (a) are intended for surgical implant into the body or (b) support or sustain life, and (c) whose failure to perform when properly used in accordance with instructions for use provided in the labeling, can be reasonably expected to result in a significant injury of the user.
2. A critical component in any component of a life support device, or system whose failure to perform can be reasonably expected to cause the failure of the life support device or system, or to affect its safety or effectiveness.