

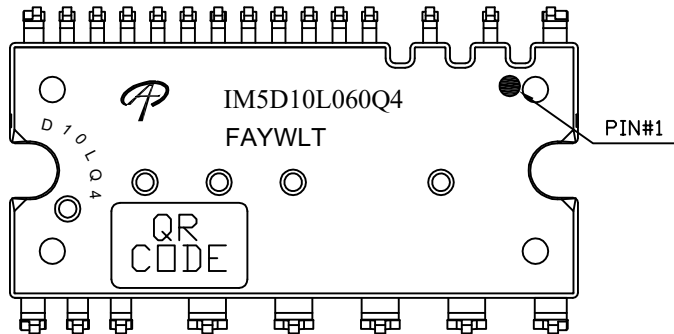

Document No.	PD-03645
Version	A
Title	AIM5D10L060Q4 Marking Description

IPM-5 PACKAGE MARKING DESCRIPTION



Green product

NOTE:	
IM5D10L060Q4	- Part number code
F	- Fab code
A	- Assembly location code
Y	- Year code
W	- Week code
L&T	- Assembly lot code
D10LQ4	- circle marking

PART NO.	DESCRIPTION	CODE
AIM5D10L060Q4	Green product	IM5D10L060Q4