

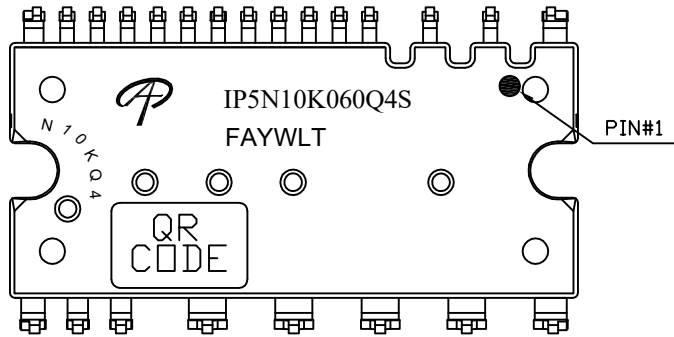

Document No.	PD-04500
Version	A
Title	AIP5N10K060Q4S Marking Description

IPM-5A PACKAGE MARKING DESCRIPTION



Green product

NOTE:	
LOGO	- AOS Logo
IP5N10K060Q4S	- Part number code
F	- Fab code
A	- Assembly location code
Y	- Year code
W	- Week code
L&T	- Assembly lot code
N10KQ4	- circle marking

PART NO.	DESCRIPTION	CODE
AIP5N10K060Q4S	Green product	IP5N10K060Q4S