

IPM-3 Package Outline

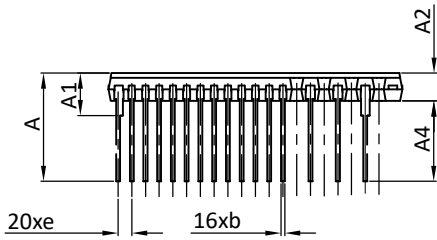

SIDE VIEW

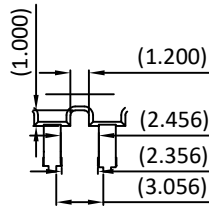

Detail A

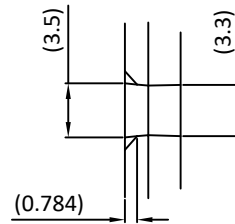

Detail B

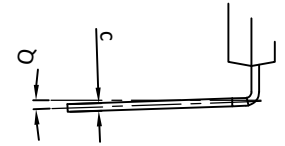

Detail C

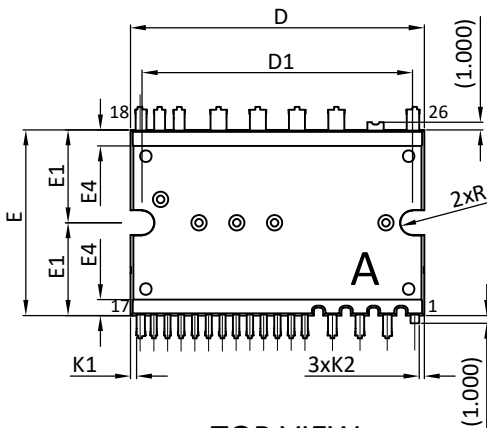

TOP VIEW

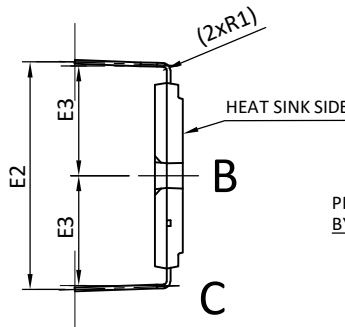

SIDE VIEW

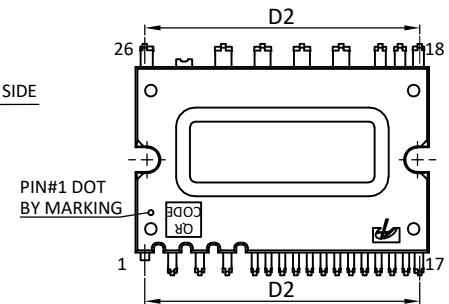

BOTTOM VIEW

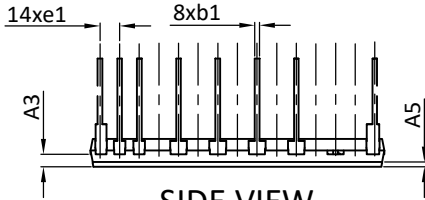

SIDE VIEW

LAND PATTERN RECOMMENDATIONS

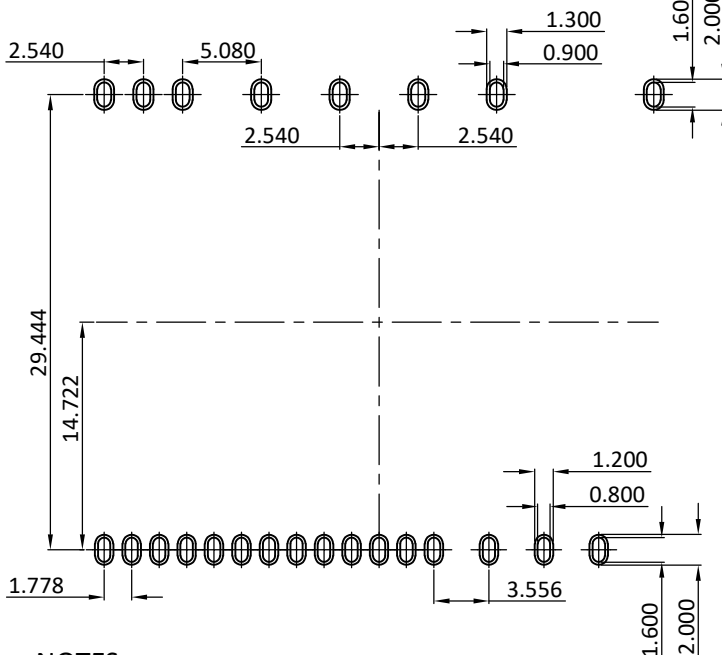

SYMBOLS	DIMENSION IN MILLIMETRES			DIMENSION IN INCHS		
	MIN.	NOM.	MAX.	MIN.	NOM.	MAX.
A	13.600	14.000	14.400	0.535	0.551	0.567
A1	5.200	5.500	5.800	0.205	0.217	0.228
A2	3.400	3.600	3.800	0.134	0.142	0.150
A3	1.550	1.600	1.650	0.061	0.063	0.065
A4	10.000	10.400	10.800	0.394	0.409	0.425
A5	0.400	0.600	0.800	0.016	0.024	0.031
b	0.400	0.500	0.600	0.016	0.020	0.024
b1	0.500	0.600	0.700	0.020	0.024	0.028
c	0.400	0.500	0.600	0.016	0.020	0.024
D	37.700	38.000	38.300	1.484	1.496	1.508
D1	34.800	35.000	35.200	1.370	1.378	1.386
D2	35.260	35.560	35.860	1.388	1.400	1.412
E	23.700	24.000	24.300	0.933	0.945	0.957
E1	11.600	12.000	12.400	0.457	0.472	0.488
E2	29.000	29.400	29.800	1.142	1.157	1.173
E3	13.800	14.200	14.600	0.543	0.559	0.575
E4	1.750	2.050	2.350	0.069	0.081	0.093
e	1.578	1.778	1.978	0.062	0.070	0.078
e1	2.340	2.540	2.740	0.092	0.100	0.108
K1	0.620	0.820	1.020	0.024	0.032	0.040
K2	0.370	0.570	0.770	0.015	0.022	0.030
R	1.500	1.600	1.700	0.059	0.063	0.067
R1	0.400REF			0.016REF		
Q	2° - 6°			2° - 6°		

UNIT: mm

NOTES

1. PACKAGE BODY SIZES EXCLUDE MOLD FLASH AND GATE BURRS, MOLD FLASH SHOULD BE LESS THAN 6 MIL.
2. TOLERANCE 0.100 MILLIMETERS UNLESS OTHERWISE SPECIFIED.
3. CONTROLLING DIMENSION IS MILLIMETER, CONVERTED INCH DIMENSIONS ARE NOT NECESSARILY EXACT.
4. () IS REFERENCE.